



City of Amarillo
Traffic Engineering Department

DRIVEWAY & PARKING MANUAL

DRIVEWAY AND PARKING MANUAL

TABLE OF CONTENTS

Section 1 - Driveways		<u>Page</u>
Introduction		1
Permit		1
Prohibited Locations		2
Definitions		2
Driveway Frequency		3
Design Standards		5
Construction		6
Fee		6
Removal		6
 Section 2 - Parking		
Introduction		17
Permit		17
Parking Layout Guidelines		17
Applicable Ordinances and Regulations		18
Design		18-19
Layout		19-20
Access		21
Parking Design Standards		22
 Tables:		
Table 1	Driveway Frequency	4
Table 2	Spacing between Driveways and Clearance	
	Distance to Intersection for Driveways	4
Table 3	Parking Layout Dimensions	23

Figures:

Figure 1	Functional Classification Map	7
Figure 2	Standard Residential Driveways	8
Figures 3-4	Standards for Residential Circular Driveways	9-10
Figure 5	Residential Driveway and Sidewalk with A.D.A. Requirements	11
Figure 6	Curb and Gutter Laydown Standards	12
Figure 7	Commercial Driveway	13
Figure 8	Industrial Driveway	14
Figure 9	Clarification	15
Figure 10	Commercial Driveway with A.D.A. Requirements	16
Figure 11	Wheel Stops	24
Figures 12-15	Typical Parking Layouts	25-28
Figure 16	Handicapped Parking Standard Layout with A.D.A. Requirements	29
Figure 17	Handicapped Parking Standard Signs	30

Appendix A – TxDOT Access Management Standards

SECTION I DRIVEWAYS

Introduction

The efficiency and safety of a roadway facility without control of access depends to a large extent upon the amount and character of roadside interference, most of which originates in vehicle movements to and from businesses, residences, or other development along the roadway. Interference resulting from indiscriminate roadside development and uncontrolled driveway connections results in lowered capacity and increased hazard. Accordingly, regulation and overall control of driveway connections are necessary to provide efficient and safe operation of the roadway.

Permit

1. A driveway permit will be obtained from the Traffic Engineering Department of the City of Amarillo before any person removes, alters, or constructs any curb, approach, or gutter on any public property. One of the requirements in obtaining a permit is the submission of a scaled plot plan showing the location of property lines, streets, alleys, proposed construction, proposed and/or existing off-street striped-off parking, all existing buildings or structures on the lot, and, where required by the Traffic Engineer, the location of driveways across the street. If the driveway is part of new construction, the driveway permit may be considered as part of the building permit obtained from the Code Enforcement Department.
2. In accordance with the Texas Department of Transportation (TxDOT) Access Management Manual, the City accepts responsibility as the permitting authority for access to the state highway system.

Where curb and gutter do not exist and thus drainage and hydraulics have not been addressed on state highways, the City Traffic Engineering Department will permit and inspect all driveways. The Texas Department of Transportation will be responsible for sizing culverts. Permitting will be in compliance with the Americans with Disabilities Act (ADA) and Texas Accessibility Standards (TAS), environmental requirements, wetland considerations if appropriate, and follow all applicable state and federal laws, rules, and regulations.

3. The Traffic Engineer has the authority to prohibit a driveway in a requested location as long as there is adequate access to the property.

4. Any applicant who is denied a driveway permit by the City Traffic Engineering Department may appeal the denial to the Traffic Commission. A written notice of appeal must be submitted to the Traffic Engineering Department within ten calendar days of the denial.

Prohibited Locations

No driveway will be permitted to encompass or encroach upon any utility or municipal facility. The relocation of utilities and municipal Facilities may be authorized by the City of Amarillo; however, such relocation will be made at the expense of the person requesting the permit.

Definitions

For the purpose of this manual, the following definitions of driveway types shall apply:

- a. Residential Driveway - One providing access to a single family residence or a duplex.
- b. Commercial Driveway - One providing access to an office, retail, an institutional building or to an apartment building having three or more dwelling units. Such buildings are customarily serviced by trucks for an incidental rather than a principal driveway use. Industrial plant driveways, whose principal function is to serve administrative or employee parking lots, are considered Commercial Driveways.
- c. Industrial Driveway - One directly serving substantial numbers of truck movements to and from loading docks of an industrial facility, warehouse or truck terminal. A centralized retail development, such as a community or regional shopping center, may have one or more driveways specially designed, signed and located to provide access for trucks. These are classified as Industrial Driveways.

Driveway Frequency

1. In order to insure safe and efficient operation of the Amarillo street system, the frequency of direct access driveways for each functional classification of street shall be as shown in Table 1.

2. All streets classified as Highways with no frontal roads, Primary Arterial, Secondary Arterial or Collector are shown in Figure 1. All streets not designated with these classifications are considered Local streets.
3. Where special circumstances warrant, an additional driveway may be permitted. Applicants should contact the Traffic Engineering Department concerning special cases or any case not covered by the frequency standards.
4. Circular residential driveways may be installed along any street.

Table 1

Functional Classification	Frequency (Excludes Circular Driveways)	
	Residential Driveways	Commercial and Industrial Driveways
Primary Arterial	Prohibit	See Fig. 5 and Fig. 6
Secondary Arterial	Prohibit	See Fig. 5 and Fig. 6
Collector	One per frontage	One per 150' frontage
Local	Up to two per frontage	One per 150' frontage
Frontal Roads	See Appendix A for Texas Dept. of Transportation Regulations	See Appendix A for Texas Dept. of Transportation Regulations

Table 2

Functional Classification	Spacing between Driveways		Clearance Distance to Intersection for Driveways	
	Residential	Commercial	Residential	Commercial
Primary Arterial	--	150'	--	100'*
Secondary Arterial		75'	10'*	75'*
Collector	20'	75'	10'*	75'*
Local	20'	--	5'*	--

* Distance measured from Corner Curb Return

Design Standards

1. The City of Amarillo standards for the design of residential, commercial, and industrial driveways are shown in Figures 2 thru 8.
2. Based on a traffic engineering study, the Traffic Engineer or his appointed agent shall have the authority to override the driveway design standards where application of these standards would impose restrictions on the property owner that are not physically possible or practical.
3. The minimum and maximum dimensions shown allow some flexibility in the layout and design of driveways. High volume driveways which serve such land uses as large shopping centers, industrial plants, drive-in movies, etc., require special high type design based on expected traffic volumes and turning movements. Engineering judgement may override recommended dimensions if warranted by specific traffic conditions identified in a traffic impact analysis.
4. Driveways will be designed so that there are no abrupt changes in grade. (See Fig. 5 and 10).
5. Under special circumstances, such as one-way driveways on one-way streets, driveway alignment angles of less than 90° might be feasible; however, 90° alignments are required.
6. All commercial, industrial and public parking lots shall comply with the design standard for driveway and parking lots. Public parking lots shall include parking facilities that have spaces leased to the public or provided by employers for their employees.
7. A residential driveway on a street classified as "local" will be 5' to the corner and adjacent to the alley curb return. The alley curb return will be left intact and is in no way encroached upon. On collector and secondary arterial streets, the residential driveway shall be a minimum of 10' from the corner curb return, but may be adjacent to the alley curb return.

Construction

1. All driveways are to be constructed of reinforced Portland cement concrete according to City specification and will extend at least to the end of the driveway curb radii. (Fig. 3)
2. Where design standards would require a driveway to encroach upon a sidewalk, the section of sidewalk affected shall be completely removed for the entire depth of the sidewalk. The driveway and the section of sidewalk that was removed shall then be constructed monolithically.
3. It is required from a maintenance and structural standpoint to completely remove the existing curb and gutter and install monolithically the new curb, gutter and approach. All residential and commercial driveways, new and existing, are to be completely removed and installed monolithically.
4. Where the City of Amarillo removes the curb, gutter and existing driveway for street improvements such as widening or paving, the City will replace the existing curb, gutter and driveway with similar ones at no expense to the property owner. If the property owner wants a driveway in a new location or wants to upgrade his existing driveway to City standards, he will have to conform to the requirements in this manual and pay all costs for the new driveway.
5. Whenever a driveway curb crosses or is extended across a sidewalk, the sidewalk shall be ramped down to the driveway level, according to Figure 10, which is also City of Amarillo, Department of Engineering Specification No. 5.11 A.

Fee

The person obtaining a curb removal permit shall pay a fee of twenty-five dollars (\$25.00) for each permit. If any curb removal is undertaken without a permit, the subsequent permit for that removal shall double to fifty dollars (\$50.00).

Removal

All driveways existing at the time of adoption of this manual will be allowed to remain subject to safety concerns for the driving public. If an existing driveway is deemed hazardous to the driving public, the property owner will be given notice by the City of Amarillo or TxDOT at least fifteen calendar days prior to closing the driveway. Every effort will be made to relocate driveway as closely as possible to its current location. The City of Amarillo or TxDOT will be responsible for all costs associated with closing and relocating the driveway. The property owner may appeal the removal to the Traffic Commission. The appeal must be in writing and made within ten days from time of notification.

CITY OF AMARILLO
 TRAFFIC ENGINEERING
 FUNCTIONAL CLASSIFICATION MAP

- EXPRESSWAY
- PRIMARY ARTERIAL
- SECONDARY ARTERIAL
- COLLECTOR

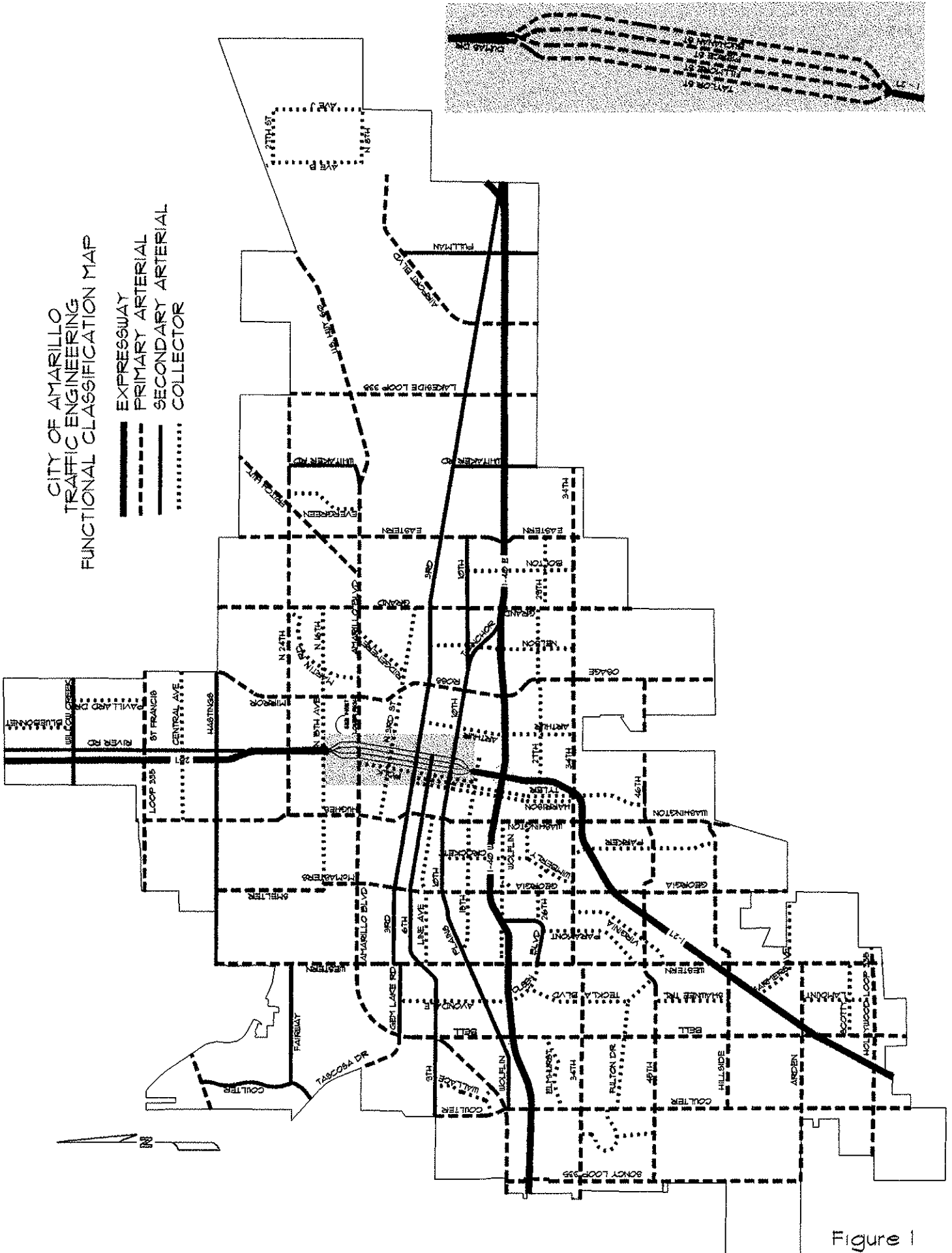
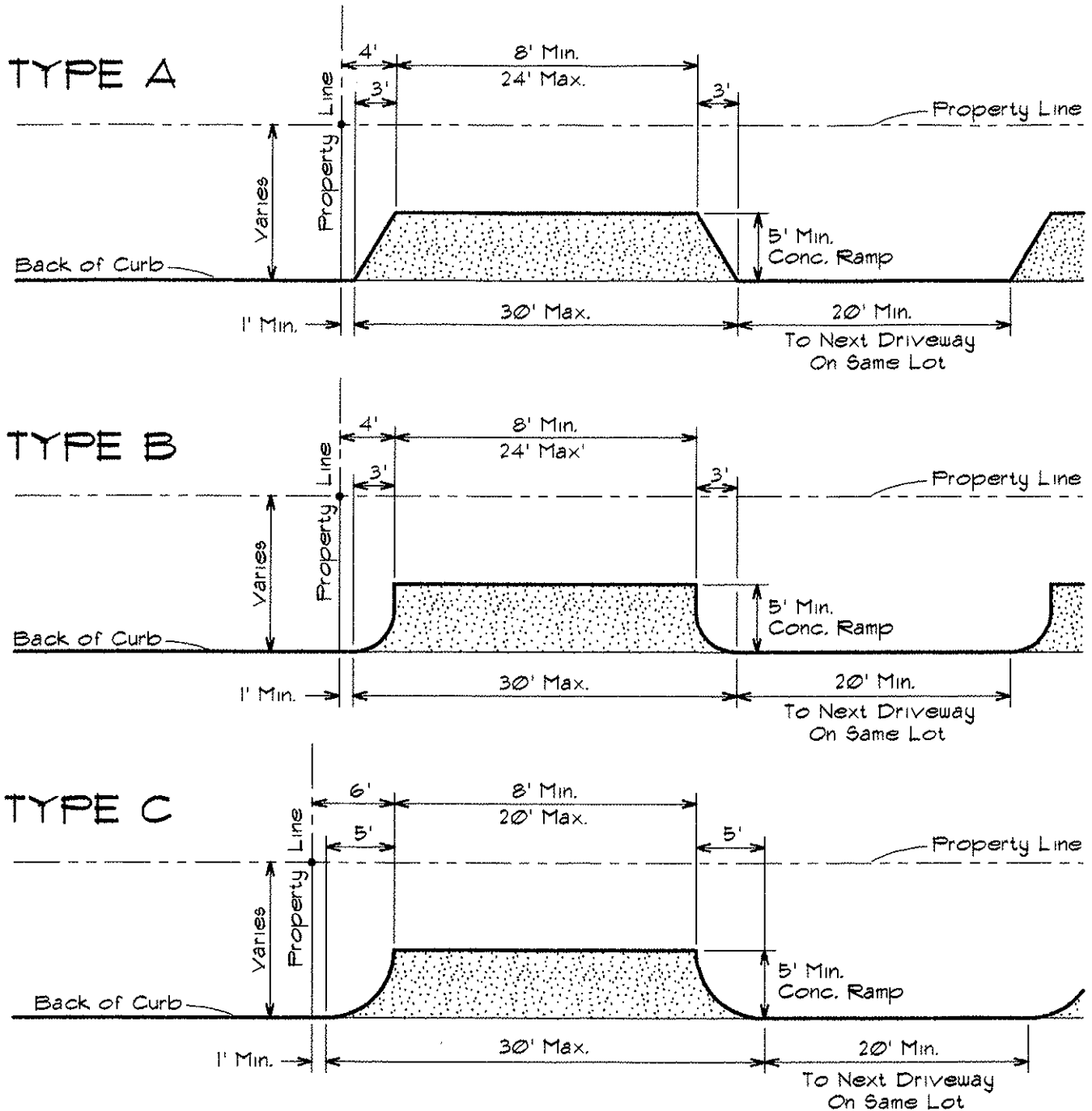

Figure 1

STANDARD RESIDENTIAL DRIVEWAYS

(ALTERNATE TYPE APPROACHES)



1. ALL NEW DRIVEWAYS ARE REQUIRED TO REMOVE EXISTING CURB AND GUTTER AND INSTALL NEW CONCRETE MONOLITHICALLY. WHEN WIDENING AN EXISTING RESIDENTIAL DRIVEWAY, THE CURB AND GUTTER CAN BE SAWCUT.
2. ALL RESIDENTIAL DRIVEWAYS ARE TO BE CONSTRUCTED WITH 6" CONCRETE ON A 1" SAND BASE AND REINFORCED WITH 6"x6" #10 WELDED WIRE MESH OR #3 REBAR ON 12" CENTERS BOTH WAYS
3. THE DIMENSIONS SHOWN ARE DESIGN STANDARDS OF THE CITY OF AMARILLO.

CALL: 342-1555 BEFORE POURING CONCRETE

Figure 2

STANDARD/ RESIDENTIAL CIRCULAR DRIVEWAYS

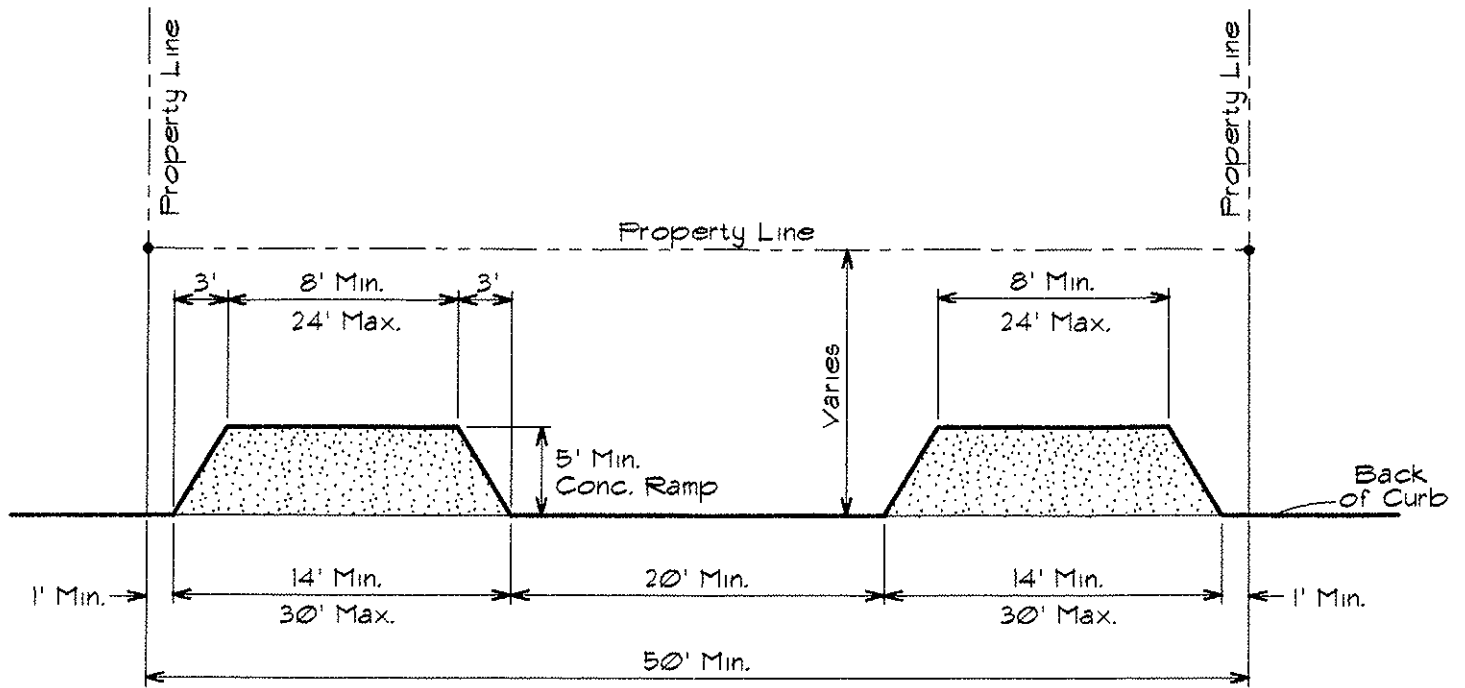

Configuration of driveway beyond the R.O.W. will be left to property owner's discretion.

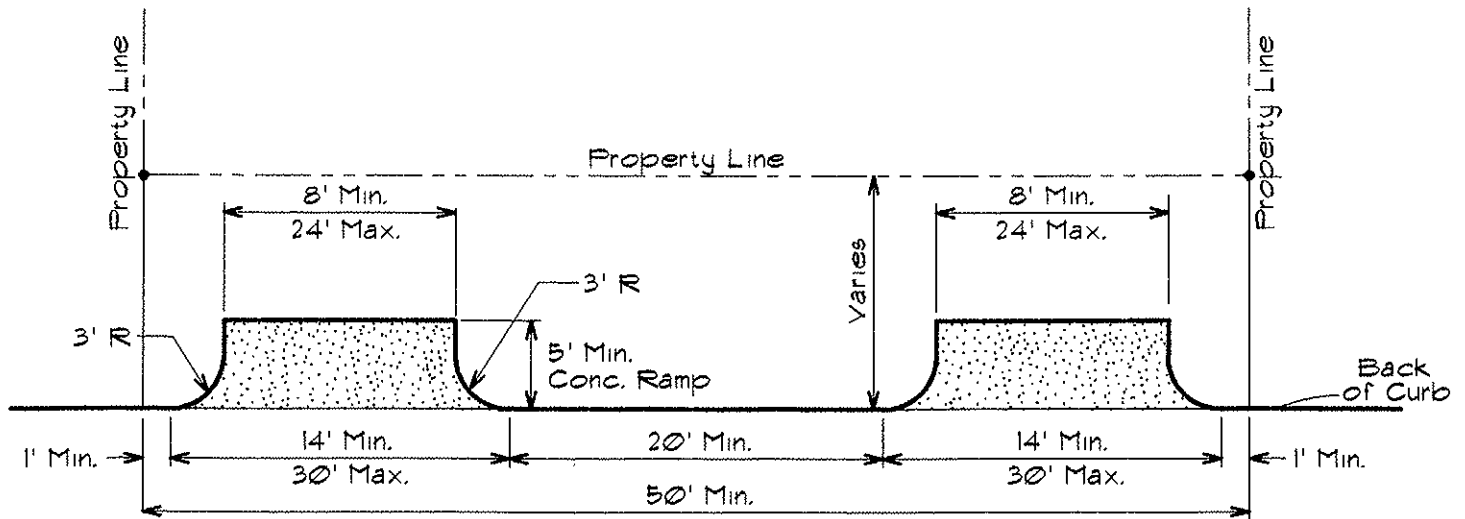

1. ALL NEW DRIVEWAYS ARE REQUIRED TO REMOVE EXISTING CURB AND GUTTER AND INSTALL NEW CONCRETE MONOLITHICALLY. WHEN WIDENING AN EXISTING RESIDENTIAL DRIVEWAY, THE CURB AND GUTTER CAN BE SAWCUT.
2. ALL RESIDENTIAL DRIVEWAYS ARE TO BE CONSTRUCTED WITH 6" CONCRETE ON A 1' SAND BASE AND REINFORCED WITH 6"x6' #10 WELDED WIRE MESH OR #3 REBAR ON 12' CENTERS BOTH WAYS
3. THE DIMENSIONS SHOWN ARE DESIGN STANDARDS OF THE CITY OF AMARILLO.

CALL: 342-1555 BEFORE POURING CONCRETE

Figure 3

STANDARD/ RESIDENTIAL CIRCULAR DRIVEWAYS

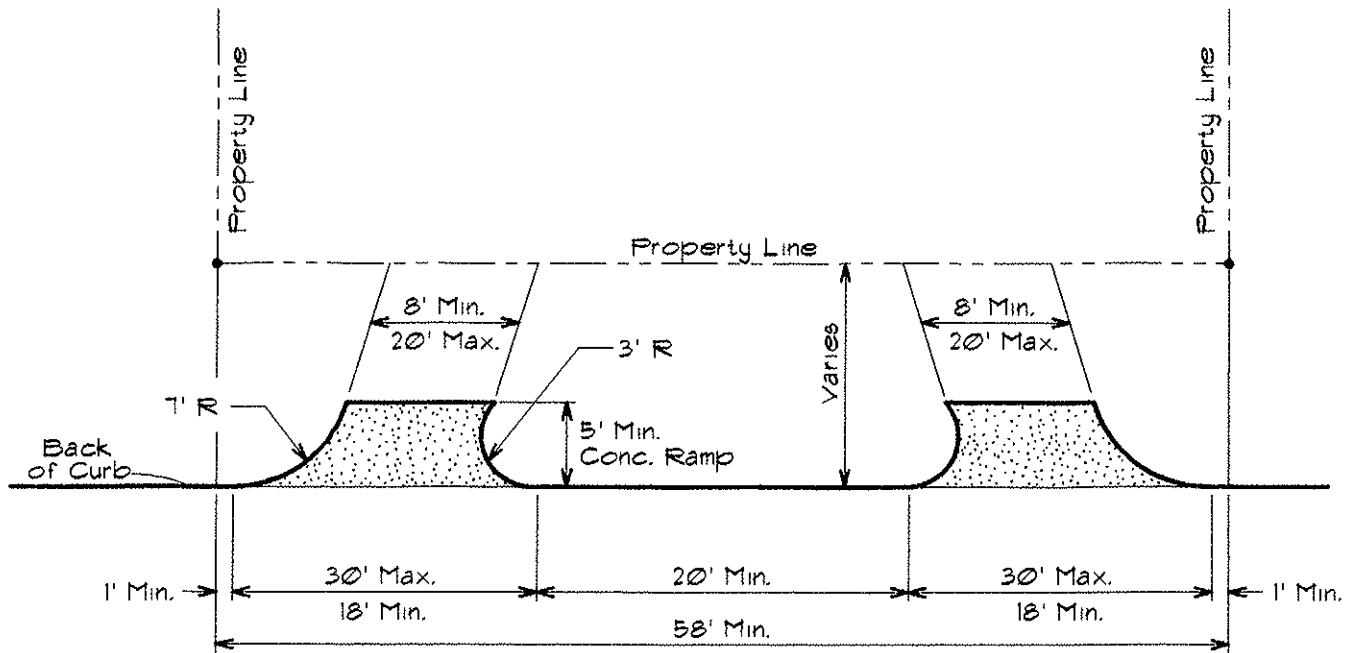

Configuration of driveway beyond the R.O.W. will be left to property owner's discretion.

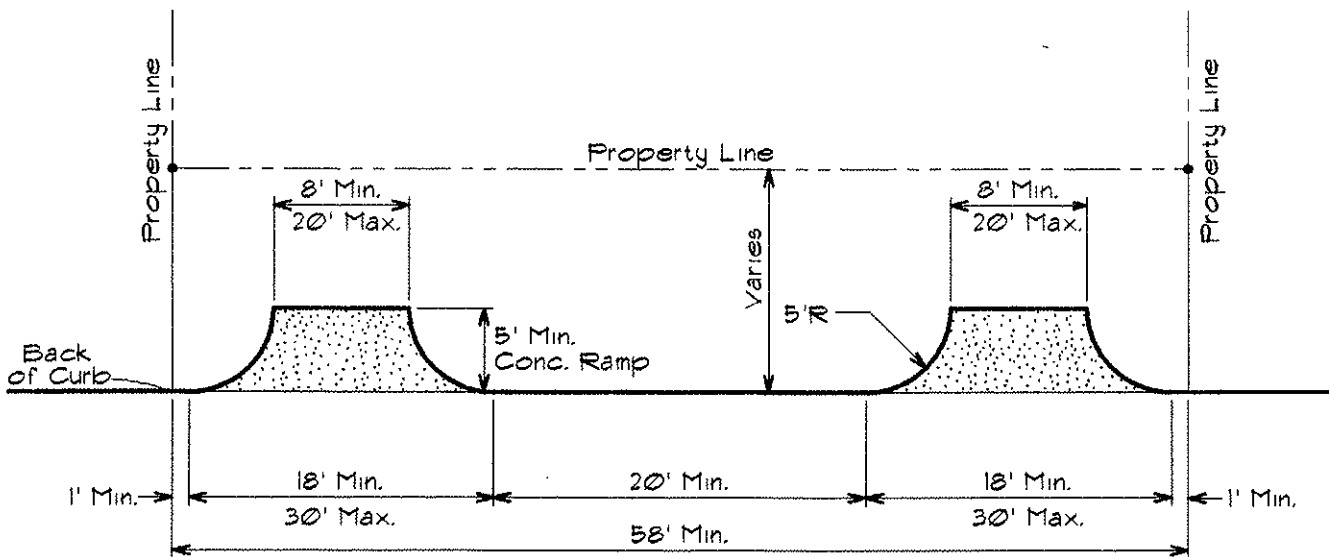

1. ALL NEW DRIVEWAYS ARE REQUIRED TO REMOVE EXISTING CURB AND GUTTER AND INSTALL NEW CONCRETE MONOLITHICALLY. WHEN WIDENING AN EXISTING RESIDENTIAL DRIVEWAY, THE CURB AND GUTTER CAN BE SAWCUT.
2. ALL RESIDENTIAL DRIVEWAYS ARE TO BE CONSTRUCTED WITH 6" CONCRETE ON A 1" SAND BASE AND REINFORCED WITH 6'x6' #10 WELDED WIRE MESH OR #3 REBAR ON 12' CENTERS BOTH WAYS
3. THE DIMENSIONS SHOWN ARE DESIGN STANDARDS OF THE CITY OF AMARILLO.

CALL: 342-1555 BEFORE POURING CONCRETE

Figure 4

STANDARD RESIDENTIAL DRIVEWAY AND SIDEWALK

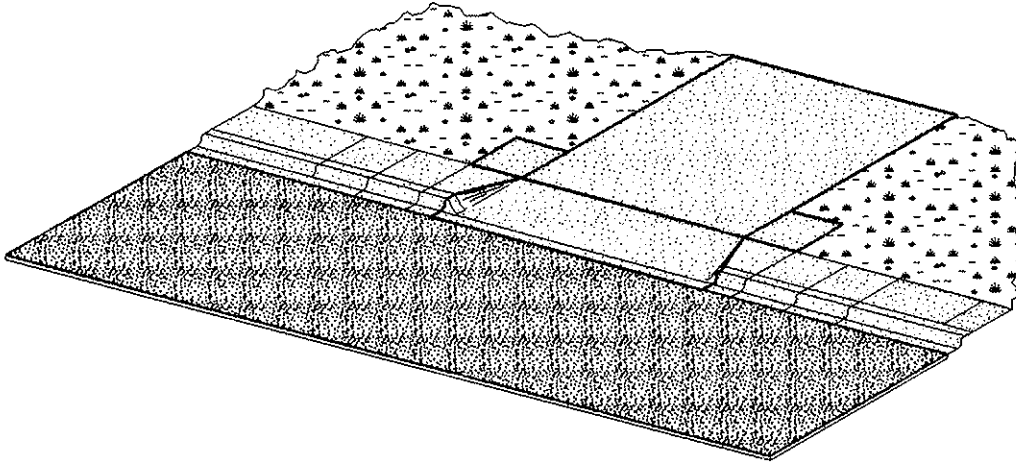

Standard residential driveway and sidewalk with A.D.A. specifications added

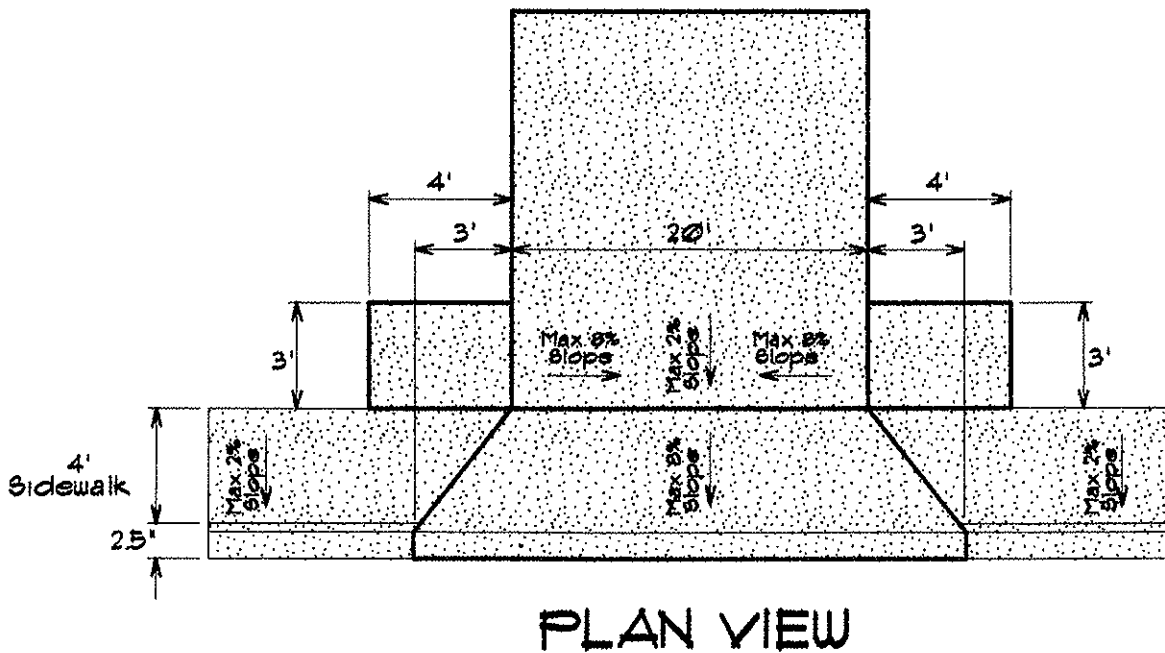
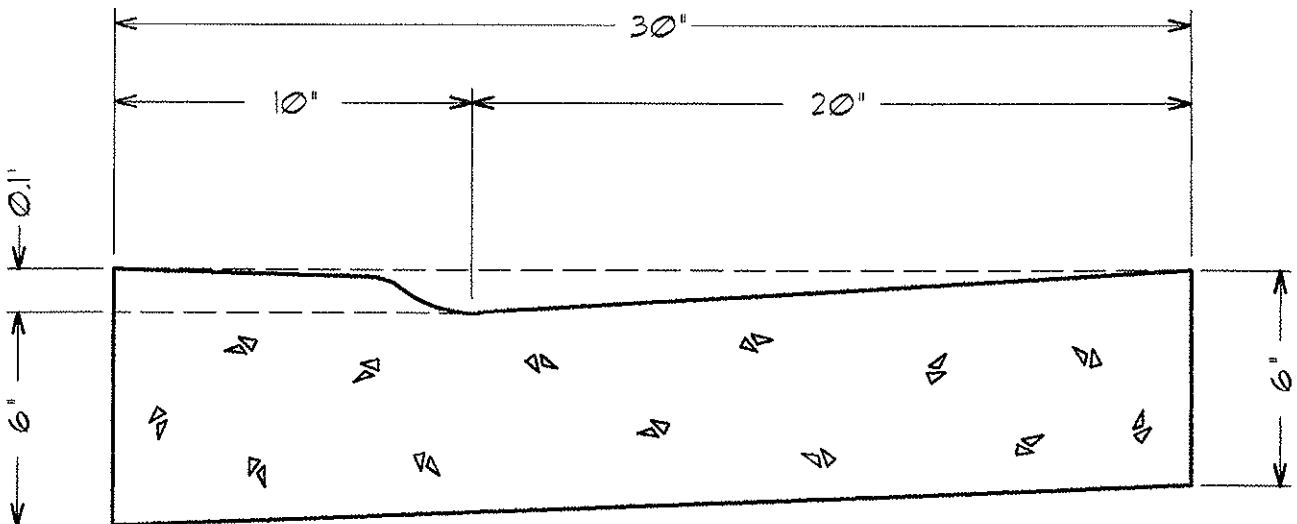
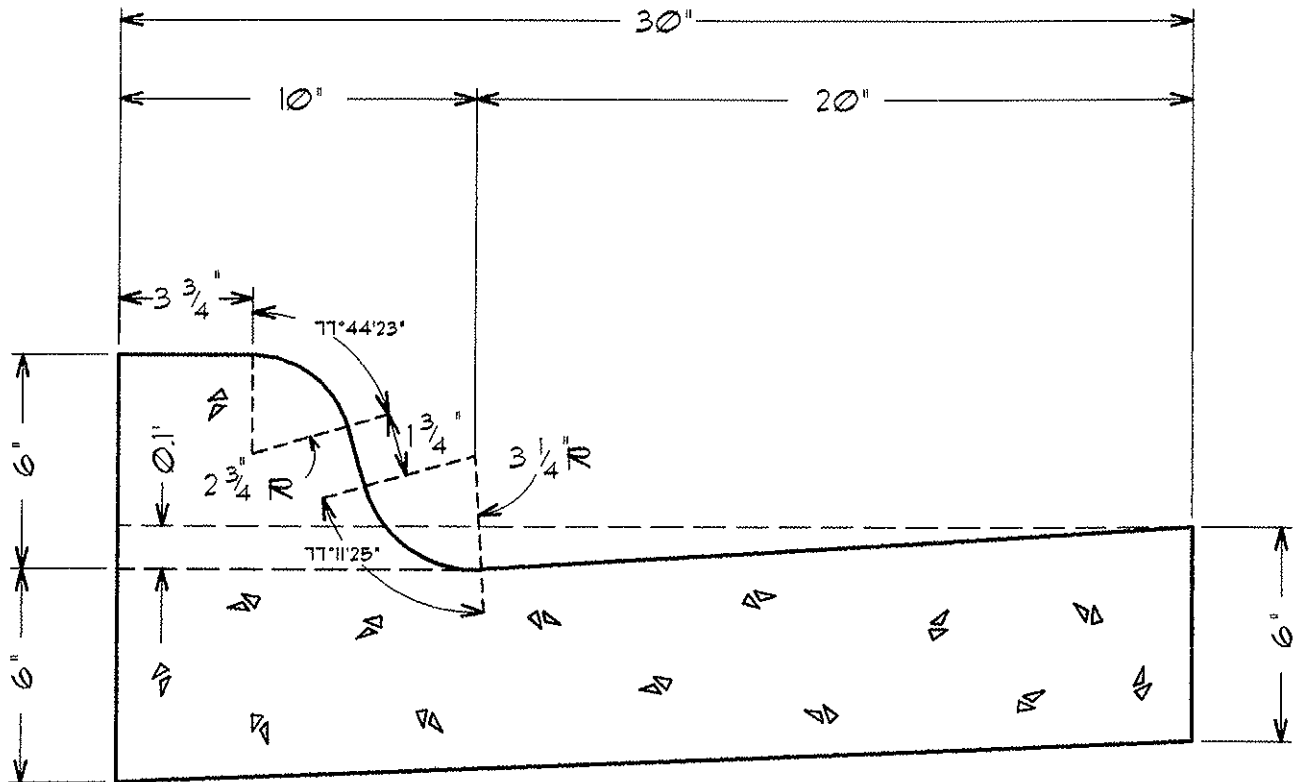

Figure 5

CURB & GUTTER DETAIL STANDARDS



1. THE DIMENSIONS SHOWN ARE DESIGN STANDARD OF THE CITY OF AMARILLO.
2. CONCRETE TO BE CLASS "A" 3000# PER SQUARE INCH COMPRESSIVE STRENGTH, ENTRAINED AIR
3. THE ENTIRE SECTION OF CURB & GUTTER SHALL BE REPLACED IF CRACKED WITHIN THE SHADED AREA ABOVE.
4. CALL 342-1555 BEFORE POURING CONCRETE.

Figure 6

COMMERCIAL DRIVEWAY ARTERIAL

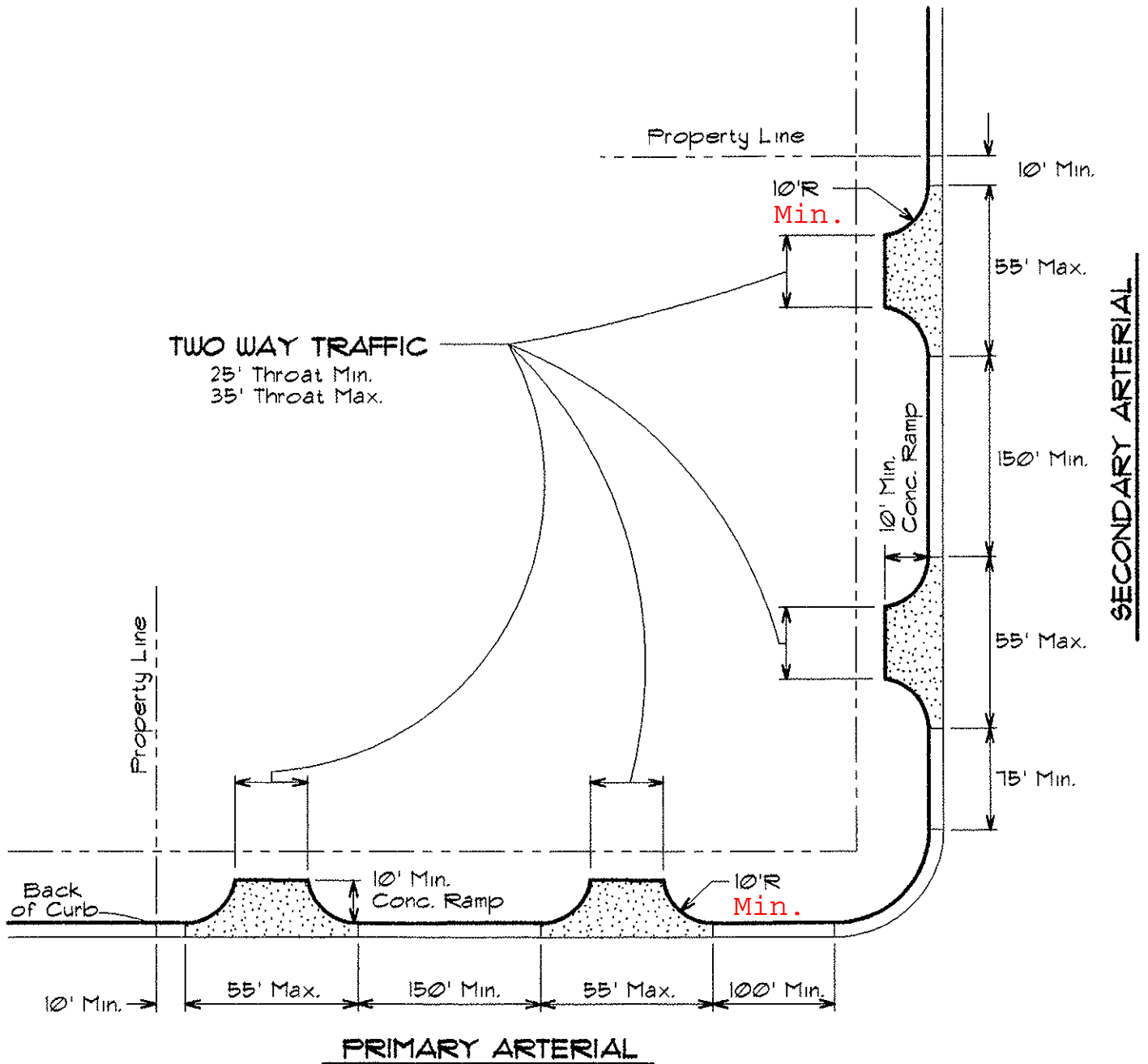

1. ALL COMMERCIAL DRIVEWAYS EXISTING OR NEW TO BE COMPLETELY REMOVED AND INSTALLED MONOLITHICALLY.
2. ALL COMMERCIAL DRIVEWAYS ARE TO BE CONSTRUCTED WITH 8" CONCRETE ON A 1" SAND BASE AND REINFORCED WITH #4 REBAR ON 12" CENTERS BOTH WAYS.
3. THE DIMENSIONS SHOWN ARE DESIGN STANDARDS OF THE CITY OF AMARILLO.
4. CENTER LINE OF DRIVEWAY AND PARKING AISLES MUST ALIGNED.

CALL: 342-1555 BEFORE POURING CONCRETE

Figure 7

INDUSTRIAL DRIVEWAY

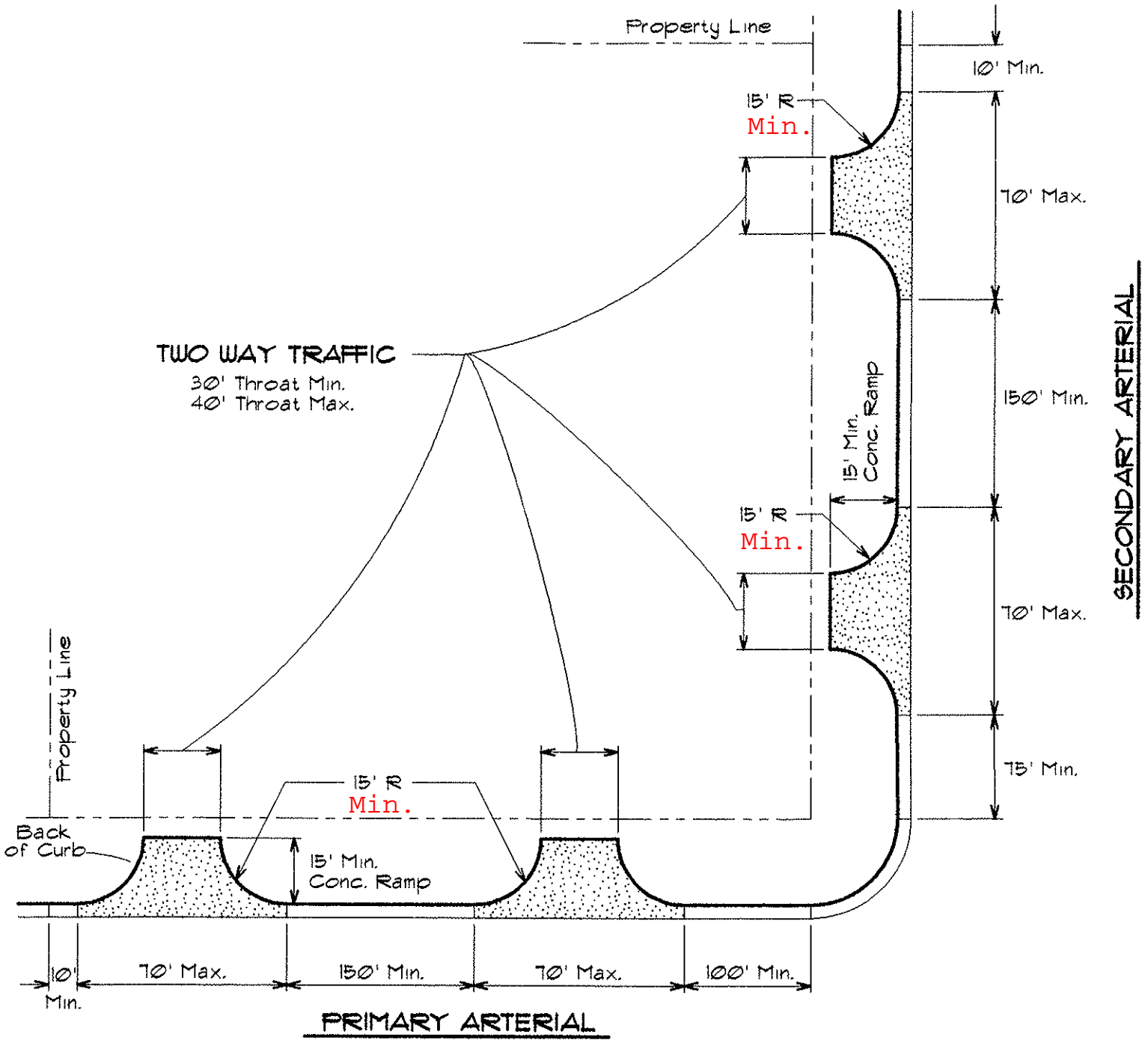

1. ALL COMMERCIAL DRIVEWAYS EXISTING OR NEW TO BE COMPLETELY REMOVED AND INSTALLED MONOLITHICALLY.
2. ALL COMMERCIAL DRIVEWAYS ARE TO BE CONSTRUCTED WITH 8" CONCRETE ON A 1" SAND BASE AND REINFORCED WITH #4 REBAR ON 12" CENTERS BOTH WAYS.
3. THE DIMENSIONS SHOWN ARE DESIGN STANDARDS OF THE CITY OF AMARILLO.
4. CENTER LINE OF DRIVEWAY AND PARKING AISLES MUST ALIGNED.

CALL: 342-1555 BEFORE POURING CONCRETE

Figure 8

INDUSTRIAL DRIVEWAY

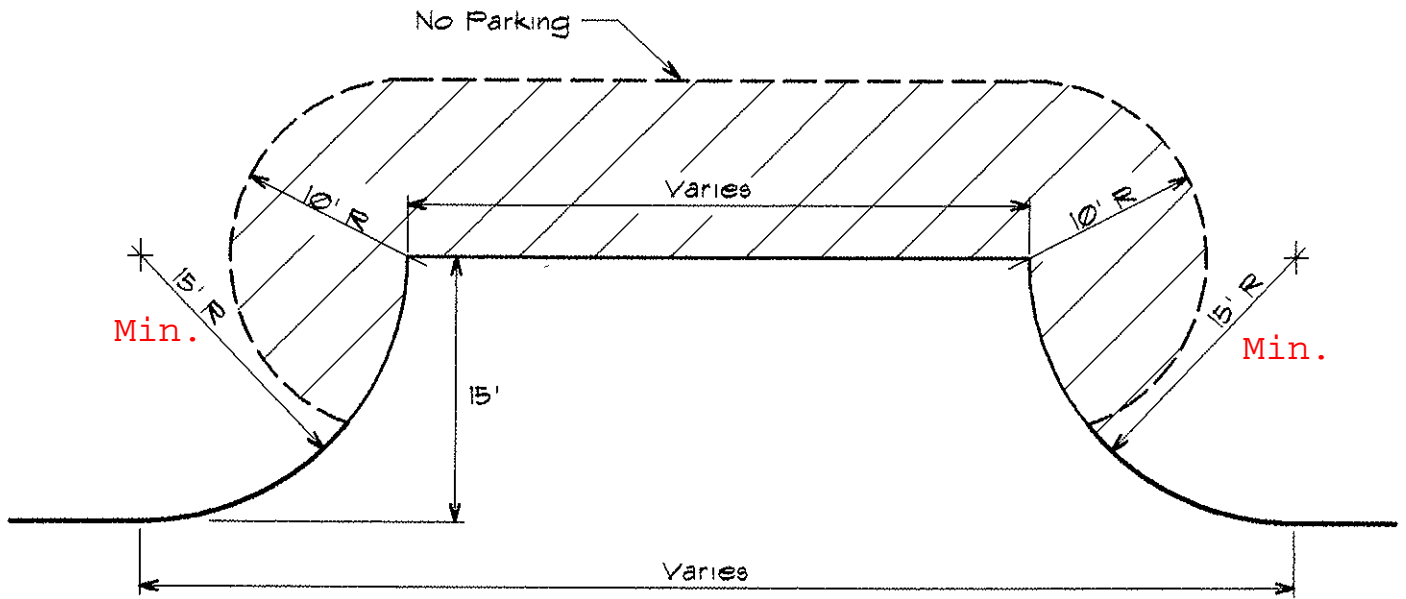

COMMERCIAL DRIVEWAY

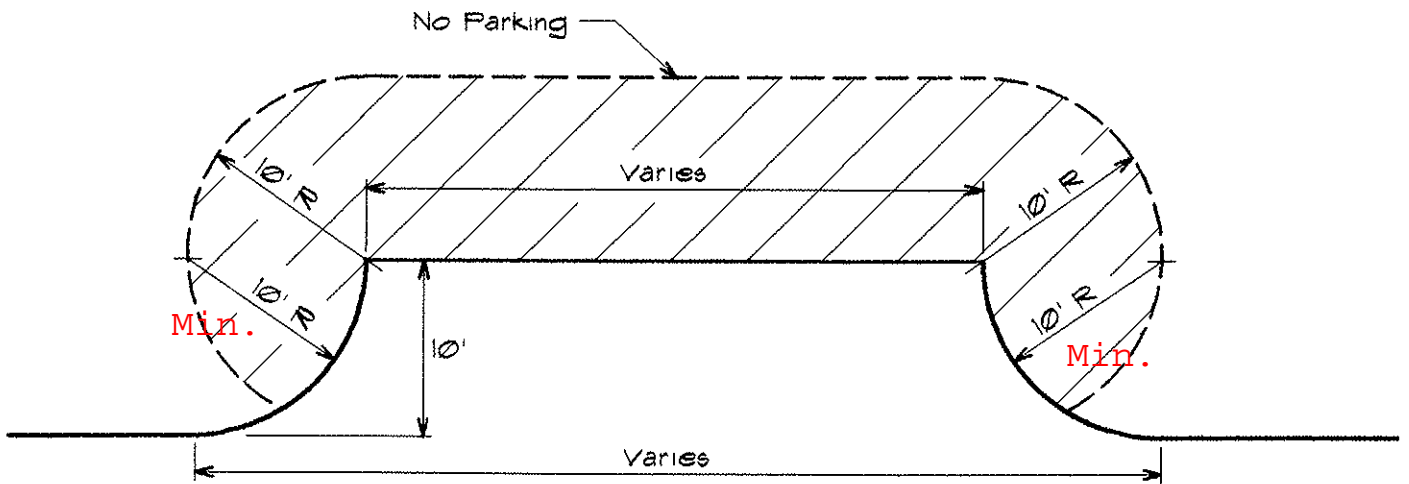

Clarification In Section II - C Parking layout Guidelines

CALL 342-1555 BEFORE POURING CONCRETE

Figure 9

STANDARD COMMERCIAL DRIVEWAY AND SIDEWALK

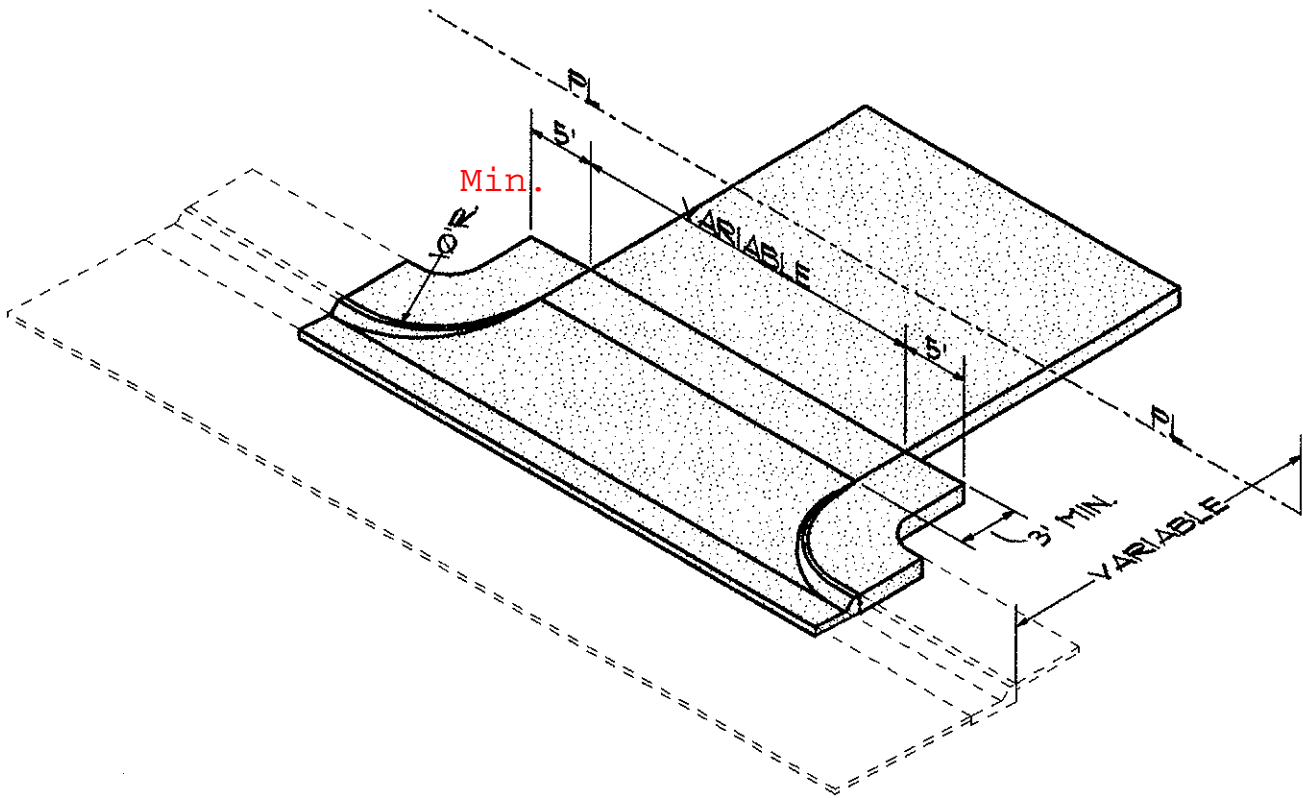

THESE DIMENSIONS ARE BASED UPON THE MIN. 10 FT. RADIUS, AND 6 FT. COMMERCIAL SIDEWALK. THEY WILL VARY FOR LARGER RADII.

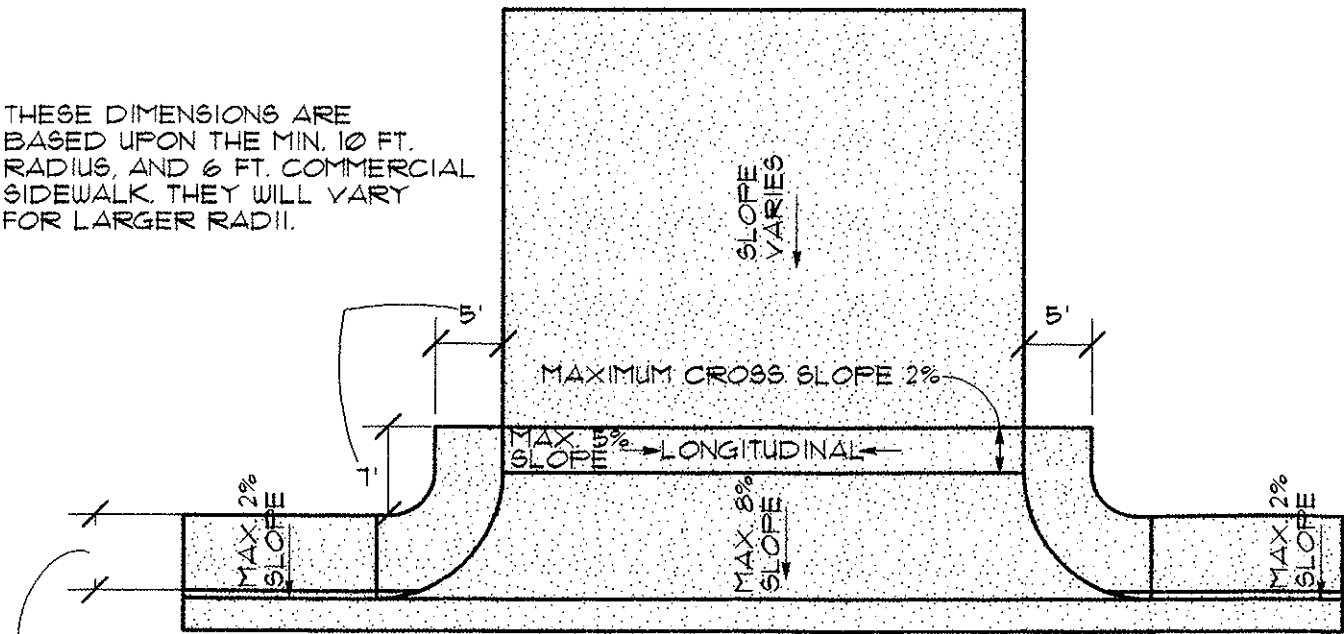

PLAN VIEW

Figure 10

SECTION II PARKING

Introduction

The internal circulation and parking patterns on a piece of property are very important considerations in properly locating driveways to provide adequate access to that property. The purpose of this section of the manual is to provide general principles and minimum standards for the layout and design of off-street parking facilities and their associated driveways. The parking layout for a particular lot or area is best selected by a trial-and-error process, tailoring the pattern to the dimensions, area and shape of the parcel available, with consideration for the various controlling factors which will be discussed below.

Permit

1. A building permit will be obtained from the Code Enforcement Department of the City of Amarillo for any new parking space or change in any existing paved off-street parking space. For new construction, this permit may be considered part of the building permit for the structure.
2. The advisory information provided in Section II-C will be used in reviewing parking lot layout plans.

Parking Layout Guidelines

General

1. For any parking facility, the aisle and travel pattern as well as the parking pattern must be tailored to the dimensions, area and shape of the property available. The tendency when designing parking areas is to crowd as many spaces as possible into the allotted space by reducing standards, such as narrower parking stalls and narrower aisles. However, the parking standards in this manual are minimum standards and any deviation should be through increasing rather than reducing them. The best design should give full consideration to every design factor that improves access to and from the street: internal circulation, location of entrances and exits, convenience of patrons and security of vehicles.
2. In cases where the provision of a driveway for access to a parking area would cause too many driveways to be located along a street, consideration should be given to the provision of a legally documented access easement across adjacent property(s). Such easements should also be considered to insure future circulation is provided for development of either side of the lot.

Applicable Ordinances & Regulations

1. In certain cases fire lanes are required by ordinance; for applicability refer to City Ordinance Section 10.207(1).
2. Parking is not allowed on parkways in the central and other business districts as provided by Sections 16-3-180(3) & (4) of the Amarillo Code of Ordinances. However, in areas other than business districts, parking spaces on the parkway are allowed only as specified in Section 4-10-211(3)(G) of the Amarillo Zoning Ordinance.
3. No parking space shall be located less than 10 feet from the back edge of the driveway measured as shown in Figure 9.
4. Standards for handicapped parking stalls and signs are shown in Figures 16 and 17. Most types of land uses require handicapped accessible parking spaces. To determine which land uses require handicapped spaces and the number of spaces necessary, refer to the current Uniform Building Code adopted by the City of Amarillo.

Design

1. The internal circulation and entrance/exit arrangement of a parking facility is a mixture of design and operational elements. Circulation aisles should be laid out to reduce travel distance and the number of turns. A poorly designed system of aisles, which requires excessive travel and turning to find an empty parking stall, creates confusion and hazard. In large lots it is desirable, where possible, to have parking on transverse aisles only, keeping the main aisles clear for movement.
2. The most desirable internal circulation pattern is one in which each potentially vacant parking stall within a small lot or section of a larger lot must be passed once by the incoming driver seeking a space. This ideal is seldom attained, and most parking facilities are arranged so that a driver must circulate on a random basis until he finds a vacant space. On exit, the driver should have to pass only a minimum number of occupied spaces.
3. Circulation patterns should be designed so that a driver does not enter the street to get to an adjacent aisle. Also, dead-end aisles will not be permitted unless an adequate turnaround area is provided.
4. The design should provide for adequate reservoir capacity so that cars waiting to enter a facility do not obstruct the adjacent street. This is most significant when associated with such land uses as drive-in banks, theaters and restaurants, car washes, and attendant parking facilities. Reservoir requirements should reflect the differing peaking characteristics of individual facilities.

5. Location for a parking facility should include consideration of the major routes over which traffic approaches the area as well as the streets immediately adjacent to the proposed site. Also, in locating entrances and exits, it is necessary to consider not only the traffic volumes and capacities of each street but also the capacities of nearby intersections. It is generally not in the public interest to allow construction of parking facility whose access requirements would overload the adjacent streets and intersections. In this respect, the number and location of access points are of prime importance.
6. The number of driveway lanes required to service a given parking facility is dependent on (1) expected flow rates of entering and exiting vehicles, (2) method of fee collection (if any), (3) sidewalk conflicts with pedestrians, and (4) available gaps in street traffic. Along two-way streets, the gaps across both directions of traffic flow to accommodate left-turn exits must be checked separately from the near-side flow that is involved only with right-turn exits from the parking facility.
7. Changes are sometimes made in traffic flow patterns. Two-way streets become one-way, and directional reversals may be required at some future date. The location and design of parking facilities should be kept sufficiently flexible so that they may be operated even when unforeseen street changes take place.
8. Another street regulation subject to change is the prohibition of intersection turns. The left turn is usually the one that is controlled, and such restriction may strongly affect either the approach to or departure from the parking facility. A flexible operating design is essential in order to retain access in the event of turn prohibitions.

Layout

1. Ideally, parking lots should be rectangular with cars parked on both sides of access aisles and with the aisles parallel to the long dimension of the lot. The most efficient layout in large lots is a 90 degree layout covering as much of the available area as possible. This rectangular arrangement fits better into rectangular areas with minimum space wastage and permits the aisle to be used for travel in both directions. Much of the alleged difficulty with 90 degree parking has stemmed from inadequate aisle dimensions. However, where proper measurements are used, a smooth and efficient operation can be achieved.
2. When 90 degree parking is used, cars can back to the right or left and may use the aisle in either direction. Two-way aisles reduce travel distance; that is, parking and unparking cars can take the most direct route to their destinations. However, generally two-way configurations complicate traffic circulation patterns and result in a larger number of conflict points.

3. While the 90 degrees pattern is the simplest to lay out, the 45 degree and 60 degree angle stalls are much easier for drivers to enter and are preferred by them and require narrower aisles. However, acute angle parking provides fewer spaces for any length of aisle, requires deeper stalls and is relatively wasteful of space. Where space economy is not a prime consideration and convenience is, as in many suburban parking lots, acute angle parking is commonly used. Frequently, available areas are too narrow to allow the use of 90 degree parking, but are wide enough for one of the acute angles. Further, the use of angle parking in any aisle normally requires one-way travel in that aisle, and therefore the entire layout must consider the position of entrances, exits and the desired travel paths to produce the most efficient design.
4. Parking facilities with angles stalls require continuous aisles because unparking cars are always headed in their original direction. The best aisle-plan for such facilities is a series of continuous one-way aisles that alternate in direction. One-way aisles are desirable because they are most economical of space and eliminate head-on and side-swipe accidents. Drivers can also be restricted to moving only in certain directions, however, an angle of 75 degrees or less should be used to avoid drivers unintentionally going the wrong way.
5. An aid to preserving the proper internal circulation pattern is the provision of curbed islands at the end of parking rows. These islands (1) help delineate turning patterns, (2) eliminate the improper use of aisle-end areas, (3) provide good sight distance at intersections of cross aisles with access aisles, and (4) offer opportunities for landscaping, placing light poles and signs, and pedestrian safety zones.
6. Parking spaces shall not be located to a public street or alley such that ingress and/or egress from these spaces encroach on the street except in accordance with Section 26-18A(3)(g) of the Municipal Code of Ordinances.

Access

1. Entrances and exits should be held to a minimum to reduce conflict with street and pedestrian traffic. They should be placed as far as possible from street intersections to avoid traffic backups and so located as to avoid left turns or crossing movements when possible. Where the only access is to and from a two-way street, the exit and entrance should be separated as far as possible to minimize confusion, and so placed that inbound cars will not cross outbound cars. Where possible, parking lot openings should be oriented to favor right-hand turns for entering and exiting traffic. Where such design is not possible and there is considerable street traffic, it may be necessary to prohibit left turns into and out of the parking lot.

At entrances, care should be taken to prevent backups onto the street. Some of the principal causes of entry delay are sidewalk conflict with pedestrians, parking or unparking maneuvers close to the entrance, and conflicting internal circulation.

2. A serious effect of traffic control near the facility is often the backup of vehicles waiting at signals or stop signs. Such backups tend to reach maximum at the same time that peak exit demand occurs at the parking facility. Such conditions indicate that driveways should generally exit only on lower volume streets and at maximum practical distance from controlled intersections.

Parking Design Standards

1. The minimum parking space standards for the City of Amarillo are shown in Table 3, with all the dimensions being in feet. Figures 12, 13, 14 and 15 are illustrations of the dimensions listed in Table 3 for 9.0 feet stalls, one-way traffic, and commercial driveways. All parking spaces are to be delineated with permanent or semi-permanent markings including but not limited to paint striping, concrete or wooden bumpers or curb stops, and pavement marking buttons.
2. The designed standards for handicapped accessible parking spaces are shown in Figure 16. The parking stall and walkway widths are minimums. All accessible spaces shall be designated with handicap parking signs as shown in Figure 17.
3. Wooden, concrete, or asphalt stall bumpers 6 inches in height shall be provided to prevent vehicles from encroaching on street rights-of-way, alleys, and adjacent properties. A bumper shall be provided for each stall. Bumpers shall also be installed for each parking stall located directly off an alley. Locational dimensions of bumpers are shown in Figure 11.
4. Commercial and Industrial parking lots shall provide on-site circulation for vehicles. Sidewalks may not be used as part of the on-site circulation pattern of any Commercial or Industrial parking lot.
5. The developer shall have the option to install 9' or 9.5' wide parking stalls.
6. All Commercial, Industrial and public parking lots shall comply with the design standards for driveways and parking lots. Public parking lots shall include parking facilities that have spaces leased to the public or provided by employers for their employees.
7. Commercial, Industrial and public parking lots shall be paved and maintained with Portland cement concrete or asphaltic concrete hot mix.

8. The Traffic Engineer or his appointed agent shall have the authority to override the parking design standards if warranted by specific traffic conditions. Any applicant whose parking design has been denied by the City Traffic Engineer may appeal to the Traffic Commission. A written notice of appeal should be submitted to the Traffic Engineering Department within ten calendar days of the initial denial.
9. A void in a parking lot surface caused by pavement failure (a pothole) shall be immediately repaired with a material which maintains uniformity in the paving material.

PARKING LAYOUT MINIMUM DIMENSIONS

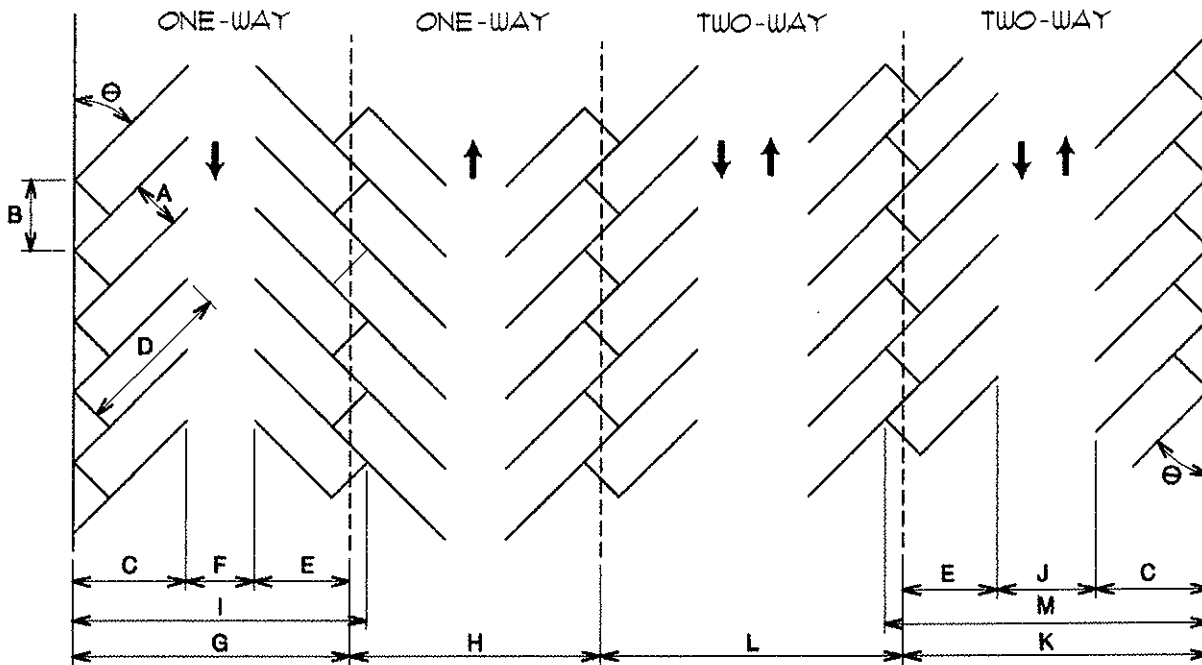

PARKING ANGLE θ	ONE - WAY					TWO - WAY							
	STALL WIDTH A	CURB LENGTH B	STALL DEPTH C	STALL LINE LENGTH D	STALL DEPTH INTERLOCK E	AISLE WIDTH F	WALL TO INTERLOCK G	INTERLOCK TO INTERLOCK H	WALL TO WALL I	AISLE WIDTH J	WALL TO INTERLOCK K	INTERLOCK TO INTERLOCK L	WALL TO WALL M
0°	8.0	22.0	8.0	8.0	8.0	12.0	28.0	28.0	28.0	22.0	38.0	38.0	38.0
30°	9.0	18.0	17.0	34.0	13.1	12.0	42.1	38.2	46.0	22.0	52.1	48.2	56.0
	9.5	19.0	17.5	35.0	13.4	12.0	42.9	38.8	47.0	22.0	52.9	48.8	57.0
45°	9.0	12.7	19.4	27.4	16.2	12.0	47.6	44.4	50.8	22.0	57.6	54.4	60.8
	9.5	13.4	19.8	28.0	16.4	12.0	48.2	44.8	51.6	22.0	58.2	54.8	61.6
60°	9.0	10.4	20.5	23.7	18.3	16.0	54.8	52.6	57.0	23.0	61.8	59.6	64.0
	9.5	11.0	20.8	24.0	18.4	14.0	53.2	50.8	55.6	22.0	61.2	58.8	63.6
75°	9.0	9.3	20.2	20.9	19.0	23.0	62.2	61.0	63.4	23.2	62.4	61.2	63.6
	9.5	9.8	20.3	21.0	19.1	22.0	61.4	60.2	62.6	22.0	61.4	60.2	62.6
90°	9.0	9.0	18.5	18.5	18.5	25.0	62.0	62.0	62.0	25.0	62.0	62.0	62.0
	9.5	9.5	18.5	18.5	18.5	24.0	61.0	61.0	61.0	24.0	61.0	61.0	61.0

Table 3

WHEEL STOPS ON 45°, 60°, 75°, 90° PARKING

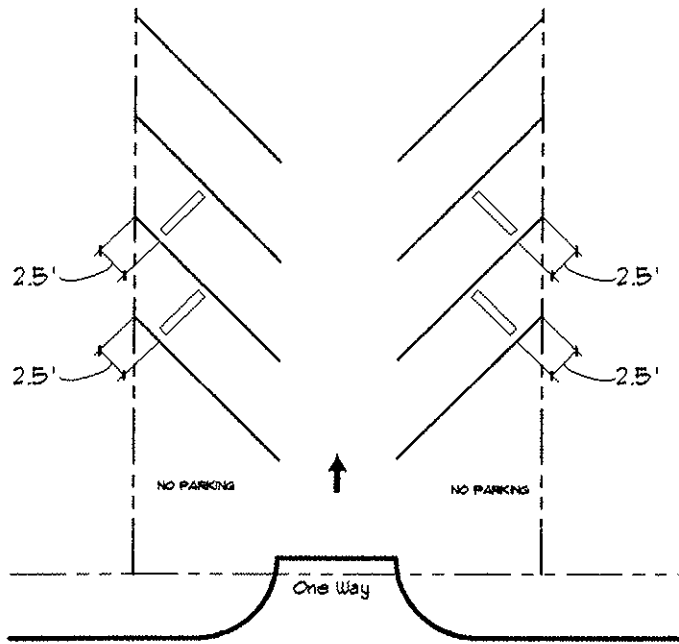

45°

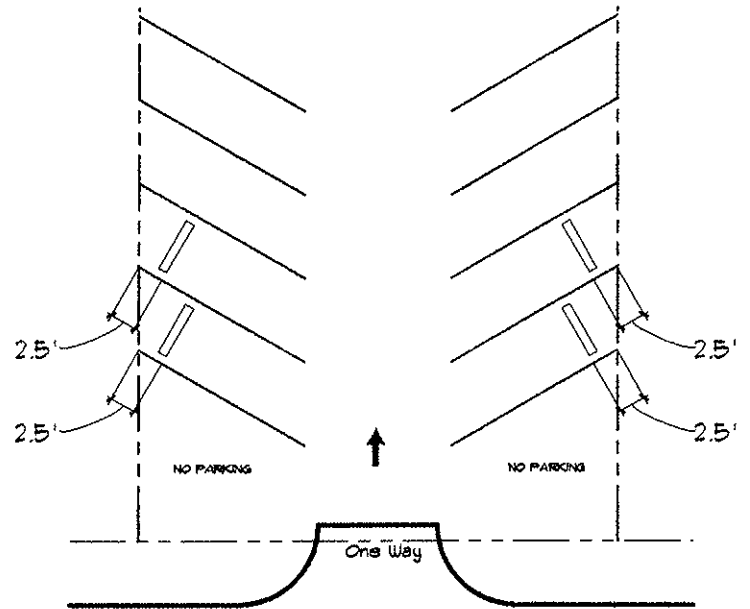

60°

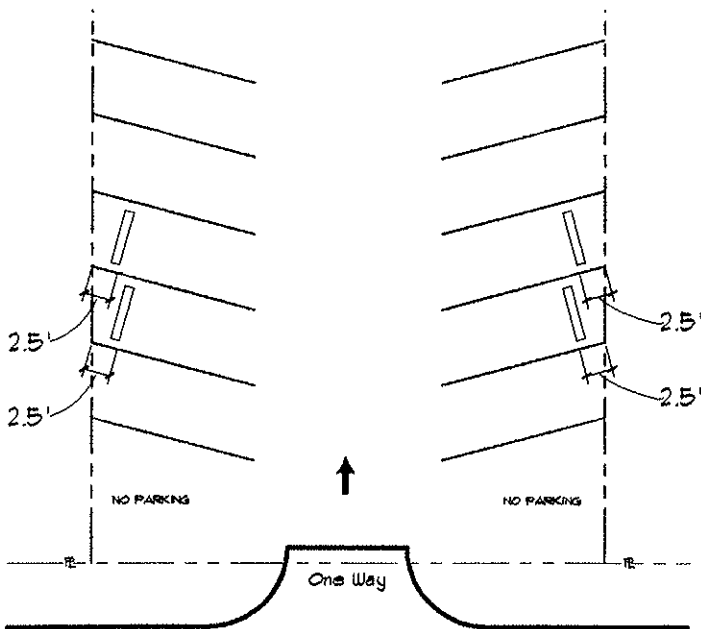

75°

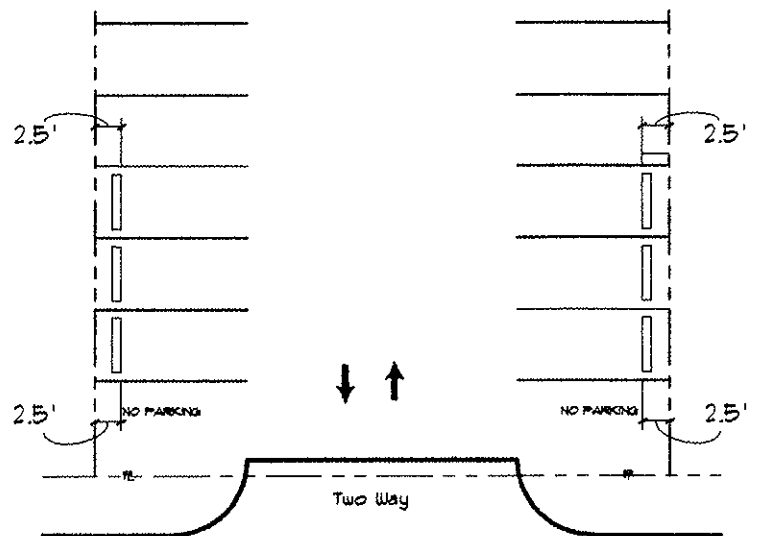

90°

Figure II

45 DEGREE PARKING

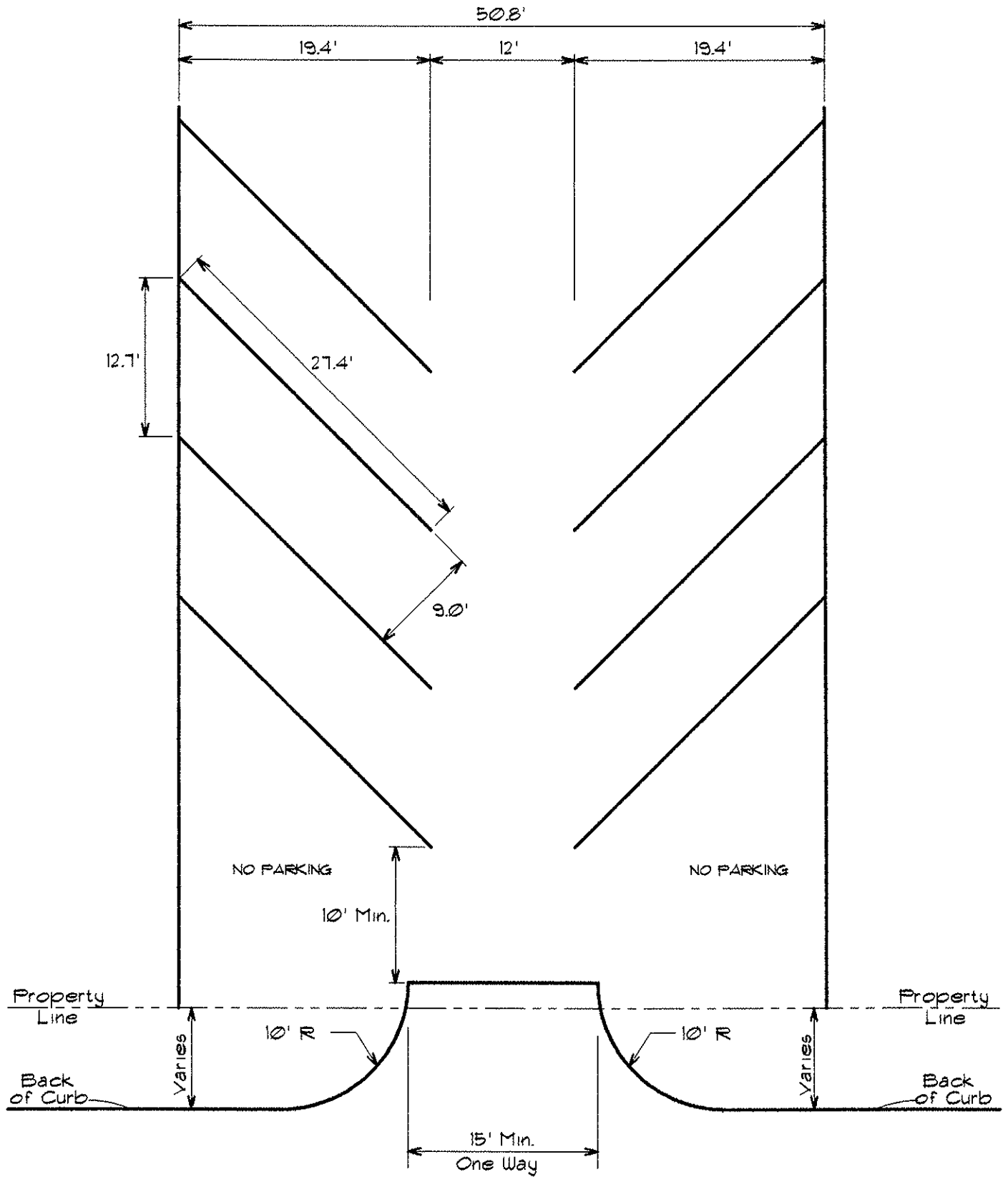

45°

Figure 12

60 DEGREE PARKING

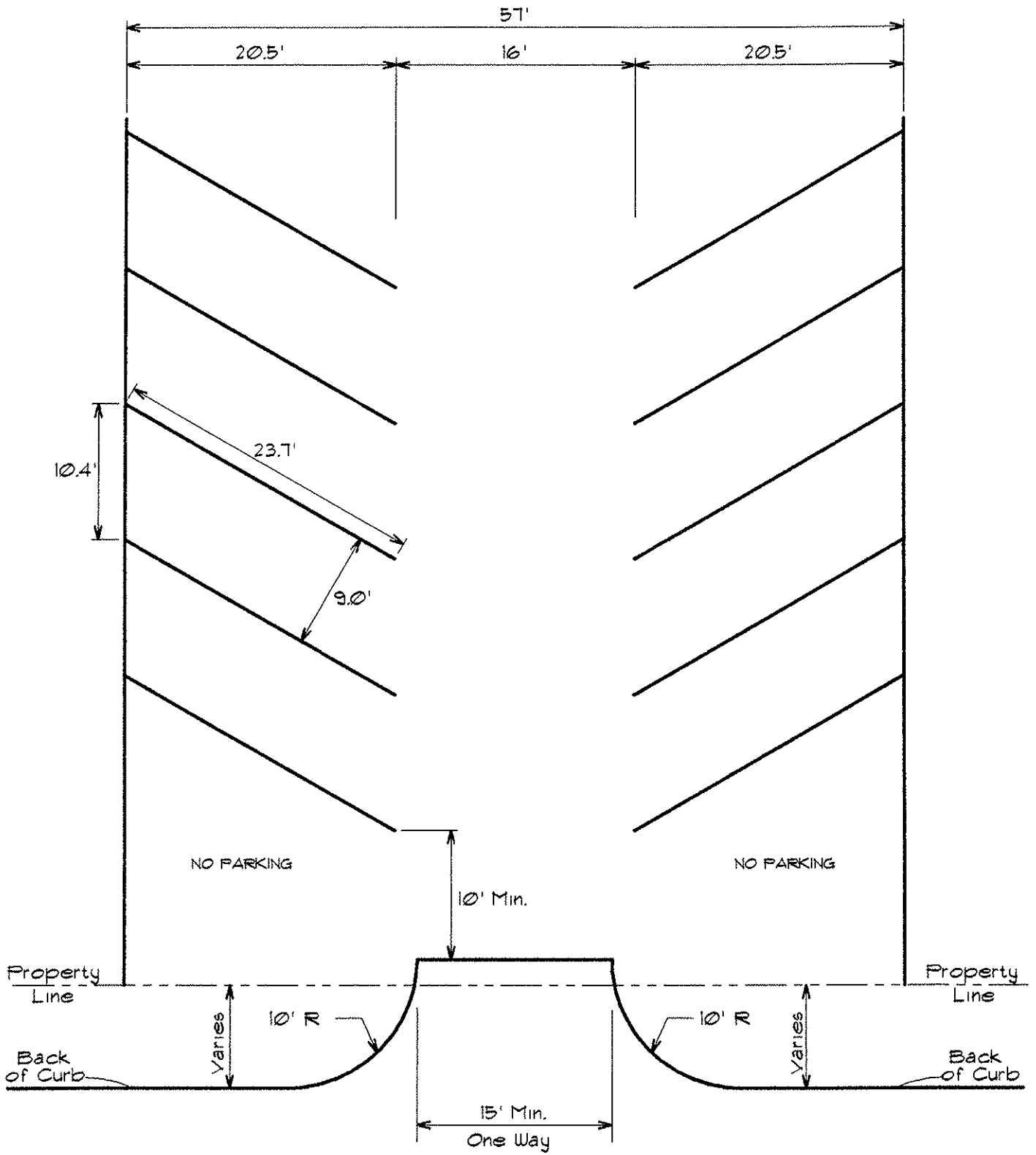
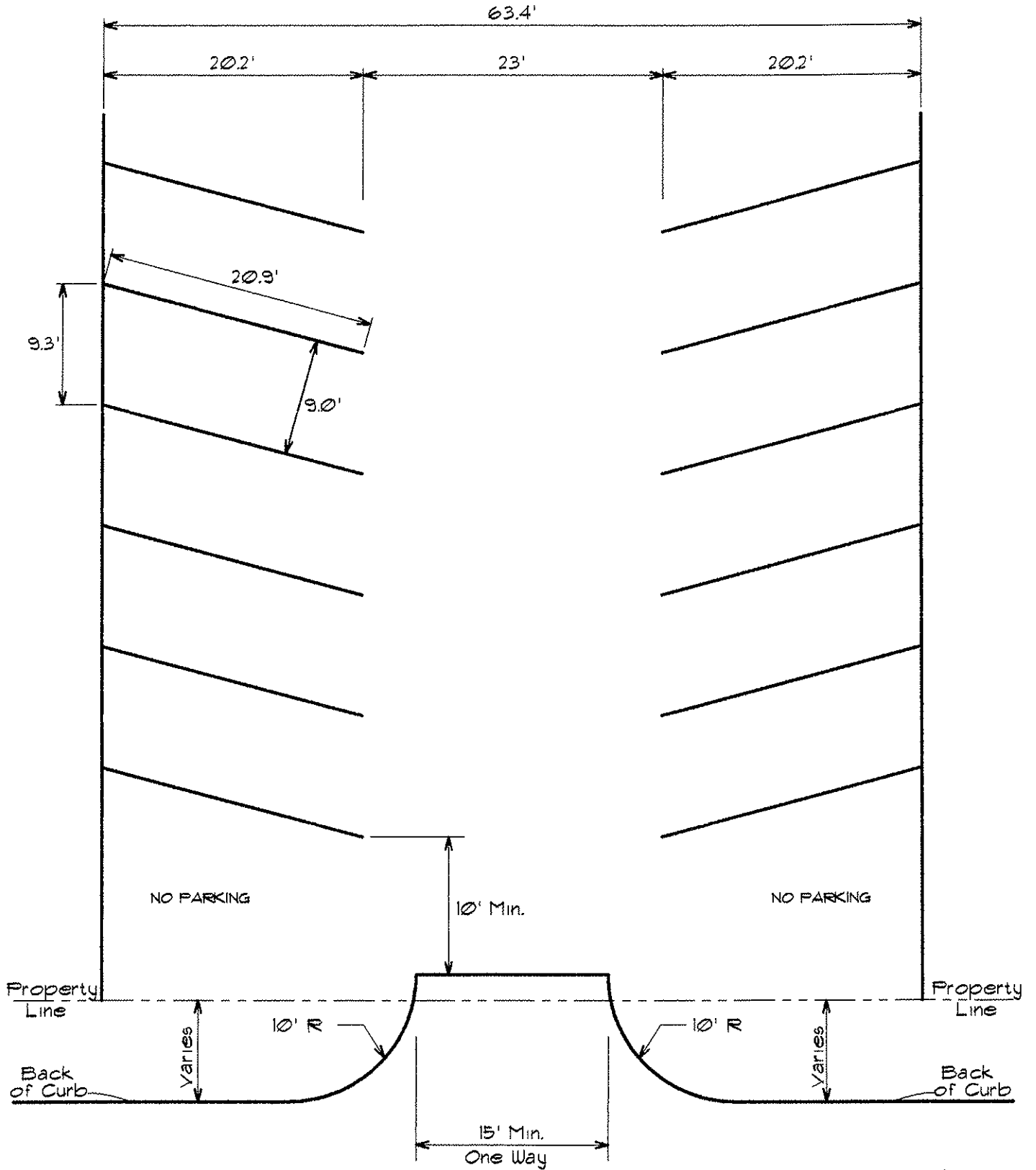

Figure 13

75 Degree Parking



75°

Figure 14

90 Degree Parking

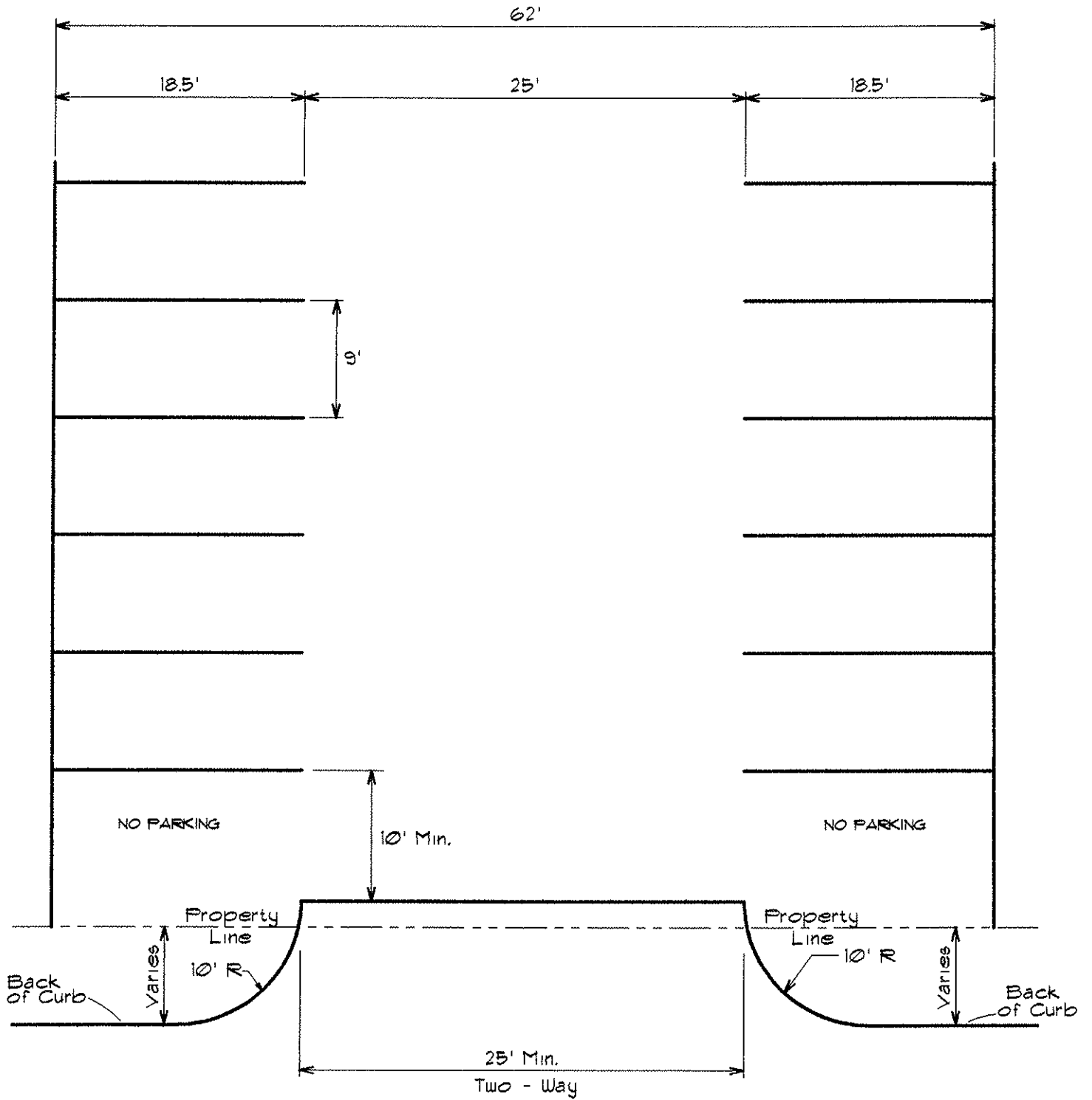
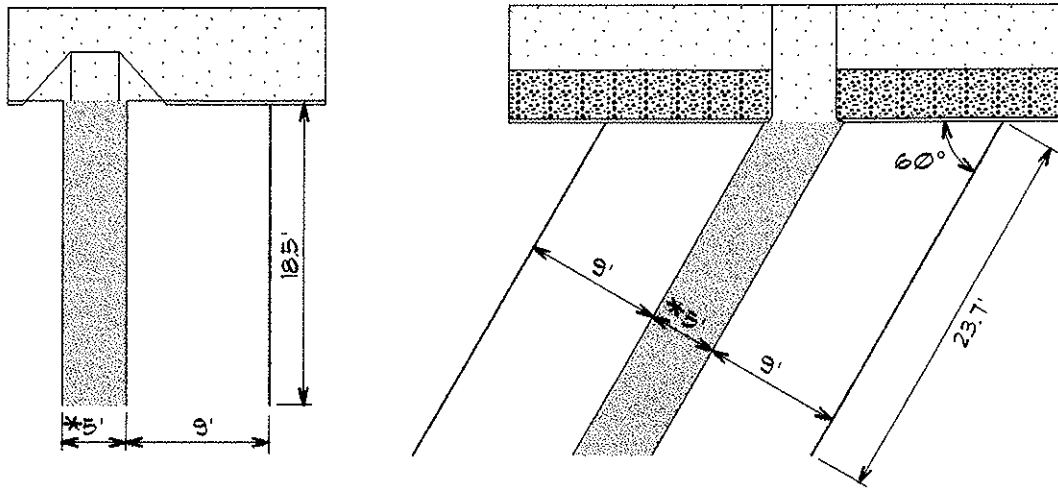
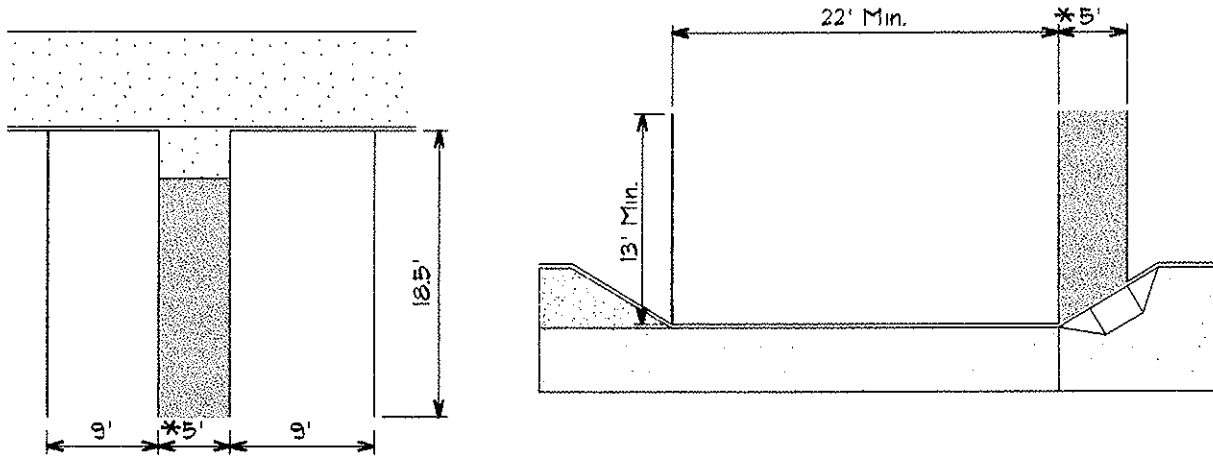

Figure 15



*8' MIN. FOR VAN ACCESSIBLE AISLE



ADA REQUIREMENTS FOR ACCESSIBLE PARKING SPACES

ACCESSIBLE PARKING SPACES SERVING A PARTICULAR BUILDING SHALL BE LOCATED ON THE SHORTEST ACCESSIBLE ROUTE OF TRAVEL FROM ADJACENT PARKING TO AN ACCESSIBLE ENTRANCE. IN PARKING FACILITIES THAT DO NOT SERVE A PARTICULAR BUILDING, ACCESSIBLE PARKING SHALL BE LOCATED ON THE SHORTEST ACCESSIBLE ROUTE OF TRAVEL TO AN ACCESSIBLE PEDESTRIAN ENTRANCE OF THE PARKING FACILITY. IN BUILDINGS WITH MULTIPLE ACCESSIBLE ENTRANCES WITH ADJACENT PARKING, ACCESSIBLE PARKING SPACES SHALL BE DISPERSED AND LOCATED CLOSEST TO THE ACCESSIBLE ENTRANCES.

FOR MOST USES, THE REQUIRED NUMBER OF ACCESSIBLE SPACES IS

TOTAL PARKING SPACES IN LOT	MINIMUM NUMBER OF ACCESSIBLE SPACES
1	1
2 TO 5	2
6 TO 25	3
26 TO 50	5
51 TO 100	8
101 TO 150	12
151 TO 200	17
201 TO 300	25
301 TO 400	35
401 TO 500	45
501 TO 1000	2 PERCENT OF TOTAL
1001 AND OVER	20 PLUS ONE FOR EA. 100 OVER 1000

AT OUTPATIENT MEDICAL UNITS AND TREATMENT FACILITIES, 10% OF THE TOTAL NUMBER OF SPACES PROVIDED SERVING THE OUTPATIENT UNIT SHALL BE ACCESSIBLE

AT UNITS OF FACILITIES THAT SPECIALIZE IN TREATMENTS OR SERVICES FOR PERSON WITH MOBILITY IMPAIRMENTS, 20% OF THE TOTAL NUMBER OF SPACES SHALL BE ACCESSIBLE.

Figure 16

HANDICAPPED PARKING SIGNS REQUIRED

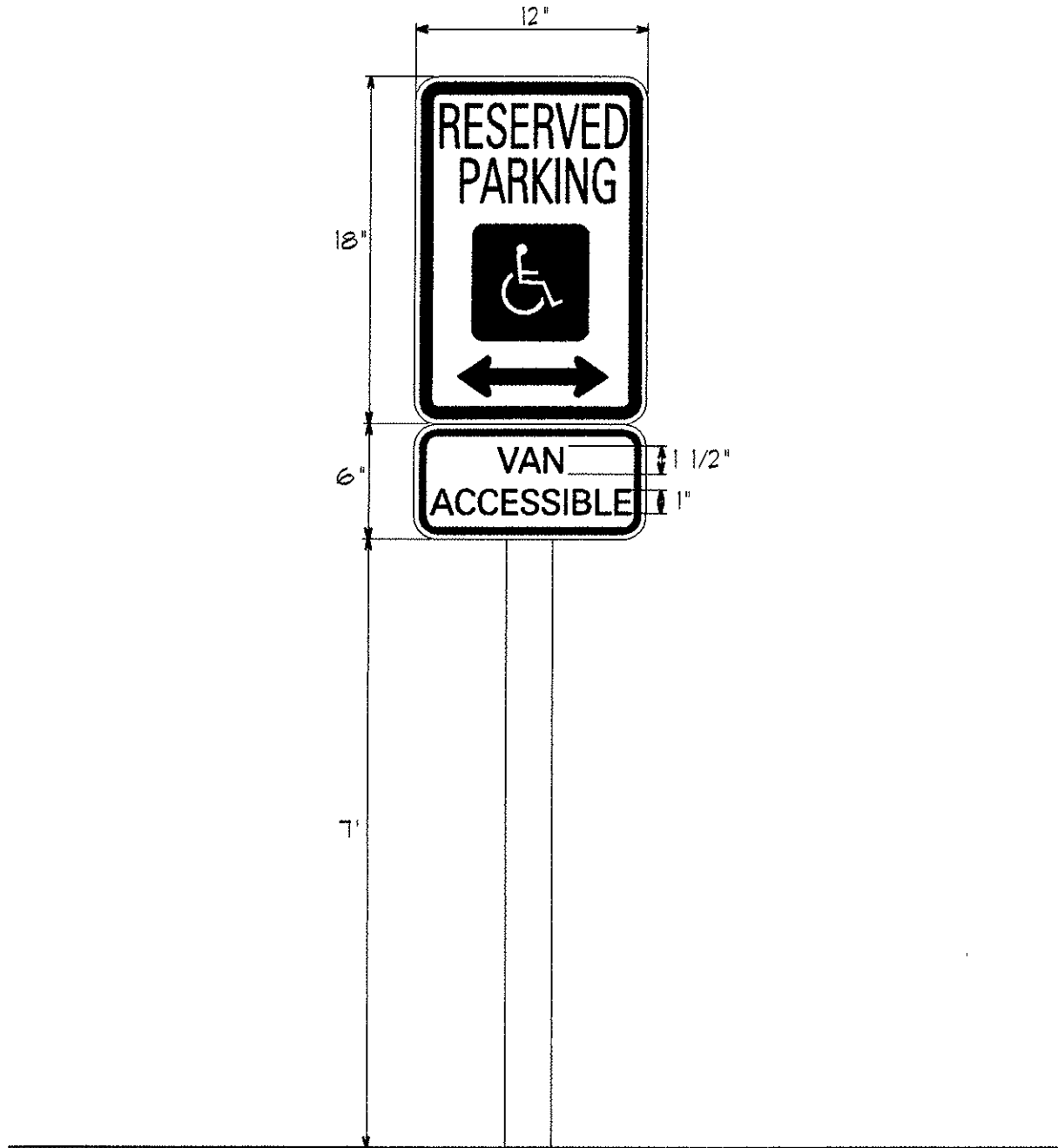

ALL ACCESSIBLE PARKING SPACES MUST BE DESIGNATED AS SUCH, SHOWING THE STANDARD INTERNATIONAL SYMBOL OF ACCESSIBILITY. SPACES MUST BE SIGNED SO THAT A VEHICLE PARKED IN A DESIGNATED SPACE WILL NOT OBSCURE THE SYMBOL.

THE TEXAS MANUAL ON UNIFORM TRAFFIC CONTROL DEVICES REQUIRES THAT SIGNS BE INSTALLED AT A HEIGHT OF 7 FEET TO THE BOTTOM OF THE SIGN.

VAN ACCESSIBLE SPACES MUST BE MARKED WITH AN ADDITIONAL SIGN 'VAN ACCESSIBLE' ADDED BELOW THE SYMBOL OF ACCESSIBILITY.

Figure 17

Table 2-1: Frontage Road Connection Spacing Criteria

Minimum Connection Spacing Criteria for Frontage Roads ⁽¹⁾⁽²⁾		
Posted Speed (mph)	Minimum Connection Spacing (feet)	
	One-Way Frontage Roads	Two-Way Frontage Roads
≤ 30	200	200
35	250	300
40	305	360
45	360	435
≥ 50	425	510

(1) Distances are for passenger cars on level grade. These distances may be adjusted for downgrades and/or significant truck traffic. Where present or projected traffic operations indicate specific needs, consideration may be given to intersection sight distance and operational gap acceptance measurement adjustments.

(2) When these values are not attainable, refer to the variance process as described in Chapter 2, Section 5.

Other State System Highways

This section applies to all state highway system routes that are not new highways on new alignments, freeway mainlanes, or frontage roads.

Table 2-2 provides minimum connection spacing criteria for other state system highways. However, a lesser connection spacing than set forth in this document may be allowed without variance in the situations described in Chapter 2, Section 5.

Table 2-2 does not apply to rural highways outside of metropolitan planning organization boundaries where there is little, if any, potential for development with current ADT volumes below 2000. For those highways, access location and design will be evaluated based on safety and traffic operation considerations. Such considerations may include traffic volumes, posted speed, turning volumes, presence or absence of shoulders, and roadway geometrics.

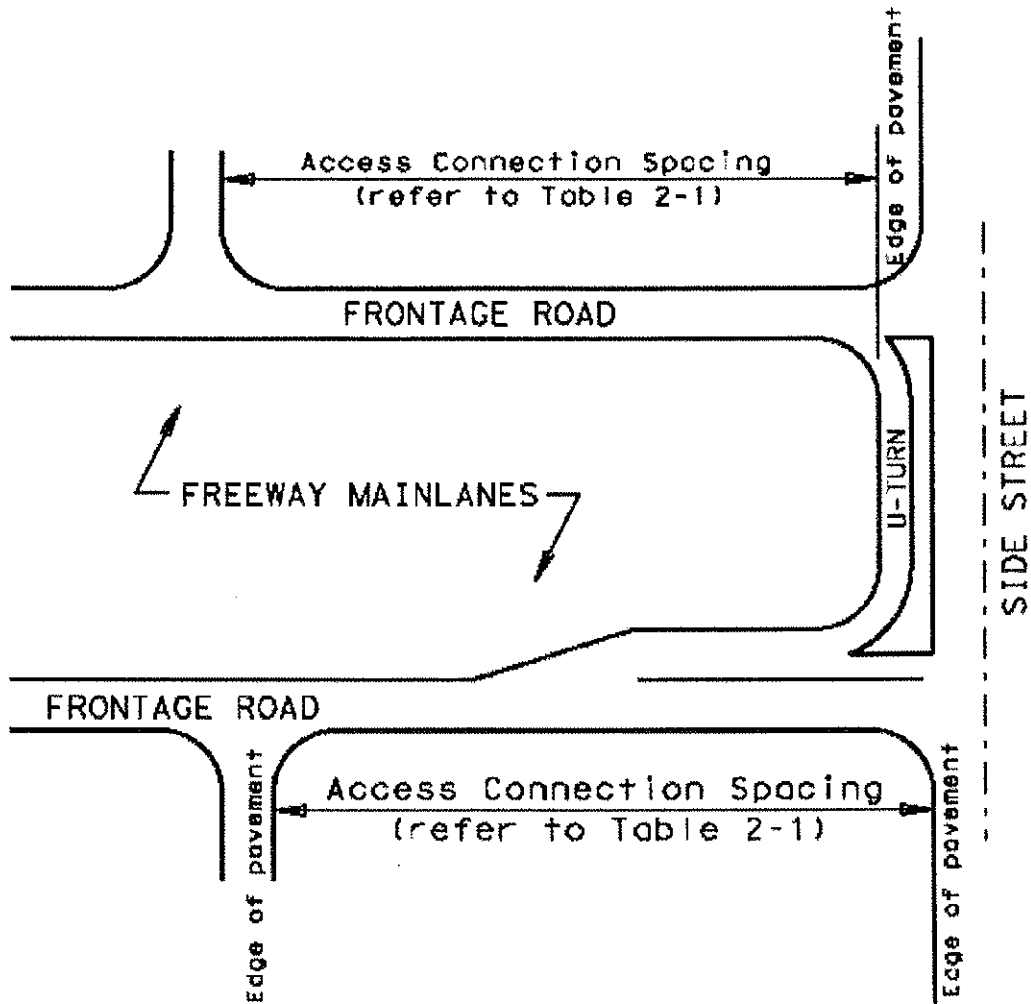

Figure 2-3. Frontage Road U-Turn Spacing Diagram

Section 3 — Number, Location, and Spacing of Access Connections

Overview

The access connection distances in the following subsections are based on stopping sight distance and are intended for passenger cars on a level grade. These distances may be increased for downgrades, truck traffic, or where otherwise indicated for the specific circumstances of the site and the roadway. In other cases, shorter distances may be appropriate to provide reasonable access, and such decisions should be based on safety and operational factors supported by an engineering study.

The distance between access connections is measured along the edge of the traveled way from the closest edge of pavement of the first access connection to the closest edge of pavement of the second access connection (Refer to Figure 2-1).

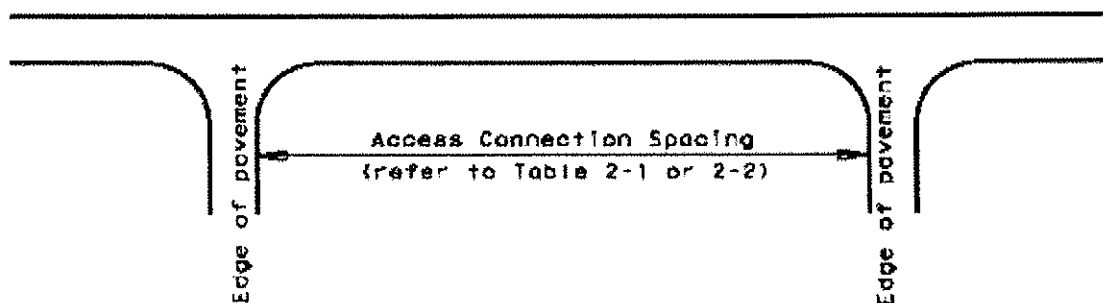

Figure 2-1. Access Connection Spacing Diagram

Conditions for granting access to the state highway system will be stated in the access permit. Violation of the conditions under which the permit was granted, as determined by the Department, may require reevaluation of the access by TxDOT.

Where topography or other existing conditions make it inappropriate or not feasible to conform to the connection spacing intervals, the location of reasonable access will be determined with consideration given to topography, established property ownerships, unique physical limitations, and/or physical design constraints. The selected location should serve as many properties and interests as possible to reduce the need for additional direct access to the highway. In selecting locations for full movement intersections, preference will be given to public roadways that are on local thoroughfare plans.