

PANHANDLE RESIDENTIAL FOUNDATION MANUAL

April 2017 edition



Optional foundation systems for use in one and two family dwellings used in conjunction with the International Residential Code®

\$5.00

The free version of this publication is available at:
amarillo.gov

Table of Contents

Section 1

Intent.....	I
-------------	---

Section 2

Foundation System Tables

Table R401.2 (a).....	2-1
Table R401.2 (b).....	2-2

Section 3

Interpretive Drawings

2 pour insulated slab on grade.....	3-1
Monolithic insulated slab on grade	3-2
Interior Foundation Beam.....	3-3
Fireplace footing.....	3-4
Exterior Grade beam to Patio.....	3-5
Exterior Grade Beam to Patio (w/load).....	3-6
Exterior Foundation Concrete Pier & Beam single Story.....	3-7
Exterior Foundation Concrete Pier & Beam Two Story.....	3-8
Exterior Foundation 12" CMU Stem Wall Single Story.....	3-9
Pier Detail	3-10
Reinforcing at Wall Intersections.....	3-11
Basement Floor Plan, Straight Stairway	3-12
Basement Floor Plan, 90 degree Stairway	3-13
Basement Wall Detail, Trenched	3-14
Basement Wall Detail, 8" Formed	3-15
Basement Wall Detail, 10" Formed	3-16
Basement Wall Detail, 8" Formed Perimeter w/Siding.....	3-17
Basement Wall Detail, 10" Formed Perimeter w/Siding.....	3-18
Basement Wall Detail, 10" Formed Perimeter w/Brick.....	3-19
Basement Wall Detail, 8" CMU.....	3-20
Basement Wall Detail, 12" CMU.....	3-21
Basement Wall Detail, 8" CMU Perimeter w/Siding.....	3-22
Basement Wall Detail, 12" CMU Perimeter w/Siding.....	3-23
Basement Wall Detail, 12" CMU Perimeter w/Brick.....	3-24
Basement Window Well Detail, Formed.....	3-25
Basement Window Well Detail, CMU.....	3-26
Insulated Accessory Building Concrete Foundation.....	3-27
Uninsulated Accessory Building Treated Wood Floor System.....	3-28
Uninsulated Accessory Building Non-Treated Floor System.....	3-29
Grounding Detail.....	3-30

Section 4

Tools and Resources

Methodology for Determining the "Effective PI"	4-1
Foundations for a Better Future.....	4-2
ASCE Residential Design Guidelines.....	4-3
Reinforcing Steel Conversion Table.....	4-4
Soils Map.....	4-5

It is the intent of this publication to provide several methods to comply with the adopted standards of this municipality as well as provide some additional opportunities to conserve energy and ensure sustainability. "The Guidelines are not intended to be Standards, but are guidelines only, reflecting the engineering opinions and practices of the committee members. They in no way replace the basic need for good engineering judgment based on appropriate education, experience, wisdom, and ethics in any particular engineering application."

The City of Amarillo here-in provides an approved structural foundation system that complies or exceeds compliance with Chapter 4 of the 2015 International Residential Code for One and Two Family Dwellings.

The presented systems are provided for optional use in design of residential structures that are considered to comply with City of Amarillo Municipal Code and the 2015 International Residential Code. These approved systems are applicable only for structures that fall within the criteria stipulated by the conditions of the approved foundation systems within the city limits of the City of Amarillo, Texas.

"The function of a residential foundation is to support the structure. The majority of foundations constructed in Texas consist of shallow, stiffened and reinforced slab-on-ground foundations. Many are placed on expansive clays and/or fills. Foundations placed on expansive clays and/or fills have an increased potential for movement and resulting distress.

National building codes have general guidelines, which may not be sufficient for the soil conditions and construction methods in the State of Texas. The purpose of this document is to present recommended practice for the design of residential foundations to augment current building codes to help reduce foundation related problems. Where the recommendations in this document vary from published methods or codes, the differences represent the experience and judgment of the majority of the committee members.

On sites having expansive clay, fill, and/or other adverse conditions, residential foundations shall be designed by licensed engineers utilizing the provisions of this document:(Recommended Practice for the Design of Residential Foundations). Expansive clay is defined as soil having a weighted plasticity index greater than 15 as defined by Building Research Advisory Board (BRAB) or a maximum potential volume change greater than 1 percent. This provision should also apply where local geology or experience indicates that active clay soils may be present. We propose that local and state governing bodies adopt this recommended practice." Excerpt from: Recommended Practice for the Design of Residential Foundations, Version 1, By the Texas Section American Society of Civil Engineers © 2002

Table R401.2(a)

For use with soils containing effective Plasticity Index of 15 – 20²

IMPORTANT NOTE: If the Web Soil survey does not state a AASHTO value, the Effective PI is assumed to be 21-25; utilize Table R401.2 (b)

The following Table R401.2(a) depicts the specific approved residential structural foundation systems configurations for specific residential criteria:

Area of Residence (square footage)	Number of Stories	Depth	Minimum Width of Perimeter Grade Beam	Size & # of Continuous Reinforcement (Top& Bottom) ^{a, c}	Width/Depth of Interior Grade Beam (20' O.C.)	Interior Beam Size & # of Continuous Reinforcement
Up to 2400SF	1	24	12	2-#4	8/8	2-#4
	2			2-#5 or 3-#4	8/8	2-#5 or 3-#4
	3			2-#5 or 3-#4	12/12	2-#5 or 3-#4
2400-5000SF	1			2-#5 or 3-#4	8/8 10/16	2-#5 2-#4
	2			2-#5 or 3-#4 or 2-#5	12/12 12/10	2-#5 or 3-#4 3-#5
	3			2-#5	12/14	3-#5
Over 5000SF ^d	Residential Design Professional Required^{cd}					

^a Reinforcement required top and bottom of footing in accordance with ACI-318

^b At intersections and corners, the #5 reinforcing bars can be tied using two bundled #4 "L" bars with minimum leg length of 5'.

^c Design Professional's are required to be licensed as an Architect or Engineer in the State of Texas in accordance with applicable laws.

^d Residential Structures Consisting of Over 5000 square feet. --- Designed by a Residential Design Professional approved by the City of Amarillo Building Official

The Table R401.2(a) is based on the following assumptions and are considered mandatory criteria if application of these approved design standards are utilized:

- The generic configurations shown in this table are based on procedures recognized by the Reference (4) Wire Reinforcement Institute's (WRI) *Design of Slab-on-Ground Foundations WRI/CRSI-81.* ^d
- The effective Plasticity Index (PI) of the sub-grade/fill is 15 to 20 when computed by the methods presented by the WRI. The determination of satisfaction of this criterion shall be provided to the Building Official. Methods shown in the appendix may be used to determine the effective PI of a specific site or the builder may use the National Recourses Conservation Service Web Soil Survey. The supporting foundation soils are assumed to have a minimum allowable soil bearing capacity of 1500 psf.
 - 2.1.1.1. Web soil survey can be obtained at: <http://websoilsurvey.nrcs.usda.gov>
 - 2.1.1.1.1. A AASHTO soil classification value of A6 or A7 will be acceptable criteria of an effective PI of 15 to 20
- All subgrade/fill material shall be compacted to a minimum 95 percent of maximum density and shall be within 2% of optimum moisture content as determined by ASTM D 698, Standard Proctor, in lifts not exceeding 12 inches (305 mm) in depth.
- "Uniform Loads are distributed across the interior floor slabs at 200 psf for single story, 275 psf for two story, and 350 psf for three story residential structures. Variations in above stated loadings are to be taken into consideration in the final individual configuration. The foundation plan must depict the anticipated specific loads on the affected foundation location. The foundation must provide a sufficient soil bearing contact area that does not impose more than 1500 psf structural loading on the soil." Consideration for foundation design assumes a maximum span 18 feet 3 inches for any exterior openings with a concentrated load not to exceed 9000 pounds.
- All reinforcing steel is Grade 60 (60,000 psi), and all concrete is 3000 psi @ 28 day's cure. All reinforcement must have at least 3" of cover where exposed directly to soil.
- The approved foundation design standards are considered minimum standards for the City of Amarillo. Selected design dimensions and reinforcement sizes that exceed these provided standards can generally be considered acceptable. Minimum interior slab thickness is shown as five inches. Exception: Experience demonstrates that four inch thick slabs typically provide adequate structural stability and overall foundation integrity for structures less than 1800SF.
- The effective Plasticity Index (PI) of the sub-grade/fill is less than 15 when computed by the methods presented by the WRI foundation design may utilize any of the approved methods in accordance with Chapter 4 of the International Residential Code. (A of AASHTO soil classification value of A4 or A5 will be acceptable criteria of an effective PI of less than 15)

Table R401.2(b)

For use with soils containing effective Plasticity Index of 21 – 25²

IMPORTANT NOTE: If the Web Soil survey does not state a AASHTO value, the Effective PI is assumed to be 21-25; utilize Table R401.2 (b)

The following Table R401.2(b) depicts the specific approved residential structural foundation systems configurations for specific residential criteria:

Area of Residence (square footage)	Number of Stories	Depth	Minimum Width of Perimeter Grade Beam	Size & # of Continuous Reinforcement (Top& Bottom) ^{a, b}	Width/Depth of Interior Grade Beam (20' O.C. maximum)	Interior Beam Size & # of Continuous Reinforcement
Up to 2400SF	1	30	12	2-#5	12/12	2-#5
	2	36	12	2-#5 or 3-#4	12/12	2-#5 or 3-#4
2400-5000SF	1	36	12	2-#5 or 3-#4	12/16	2-#5
	2	36	12	2-#5 or 3-#4	12/20	2-#5 or 3-#4
Over 5000SF ^d	<i>Residential Design Professional Required^{c,d}</i>					

^a Reinforcement required top and bottom of footing in accordance with ACI-318

^b At intersections and corners, the #5 reinforcing bars can be tied using two bundled #4 "L" bars with minimum leg length of 5'.

^c Design Professional's are required to be licensed as an Architect or Engineer in the State of Texas in accordance with applicable laws.

^d Residential Structures Consisting of Over 5000 square feet. --- Designed by a Residential Design Professional approved by the City of Amarillo Building Official

The Table R401.2(b) is based on the following assumptions and are considered mandatory criteria if application of these approved design standards are utilized:

1. The generic configurations shown in this table are based on procedures recognized by the Reference (4) Wire Reinforcement Institute's (WRI) Design of Slab-on-Ground Foundations WRI/CRSI-81.
2. The effective Plasticity Index (PI) of the sub-grade/fill is 21 to 25 when computed by the methods presented by the WRI. The determination of satisfaction this criterion shall be provided to the Building Official. Methods shown in the Appendix may be used to determine the effective PI of a specific site or the builder may use the National Resources Conservation Service Web Soil Survey. If no classification is provided on the Web Soil Survey it is assumed the effective PI is in the range of 21 to 25 for the Texas Panhandle area. The supporting foundation soils are assumed to have a minimum allowable soil bearing capacity of 1500 psf.
 - 2.1. Web soil survey can be obtained at: <http://websoilsurvey.nrcs.usda.gov>
 - 2.2. If the Web Soil survey does not state a AASHTO value, the Effective PI is assumed to be 21-25.
3. All subgrade/fill material shall be compacted to a minimum 95 percent of maximum density and shall be within 2% of optimum moisture content as determined by ASTM D 698, Standard Proctor, in lifts not exceeding 12 inches (305 mm) in depth.
4. "Uniform Loads are distributed across the interior floor slabs at 200 psf for single story and 275 psf for two story residential structures. Variations in above stated loadings are to be taken into consideration in the final individual configuration. The foundation plan must depict the anticipated specific loads on the affected foundation location. The foundation must provide a sufficient soil bearing contact area that does not impose more than 1500 psf structural loading on the soil." Consideration for foundation design assumes a maximum span 18 feet 3 inches for any exterior openings with a concentrated load not to exceed 9000 pounds.
5. All reinforcing steel is Grade 60 (60,000 psi), and all concrete is 3000 psi @ 28 day's cure. All reinforcement must have at least 3" of cover where exposed directly to soil.
6. The approved foundation design standards are considered minimum standards for the City of Amarillo. Selected design dimensions and reinforcement sizes that exceed these provided standards can generally be considered acceptable. Minimum interior slab thickness is shown as five inches. Exception: Experience demonstrates that four inch thick slabs typically provide adequate structural stability and overall foundation integrity for structures less than 1800SF.

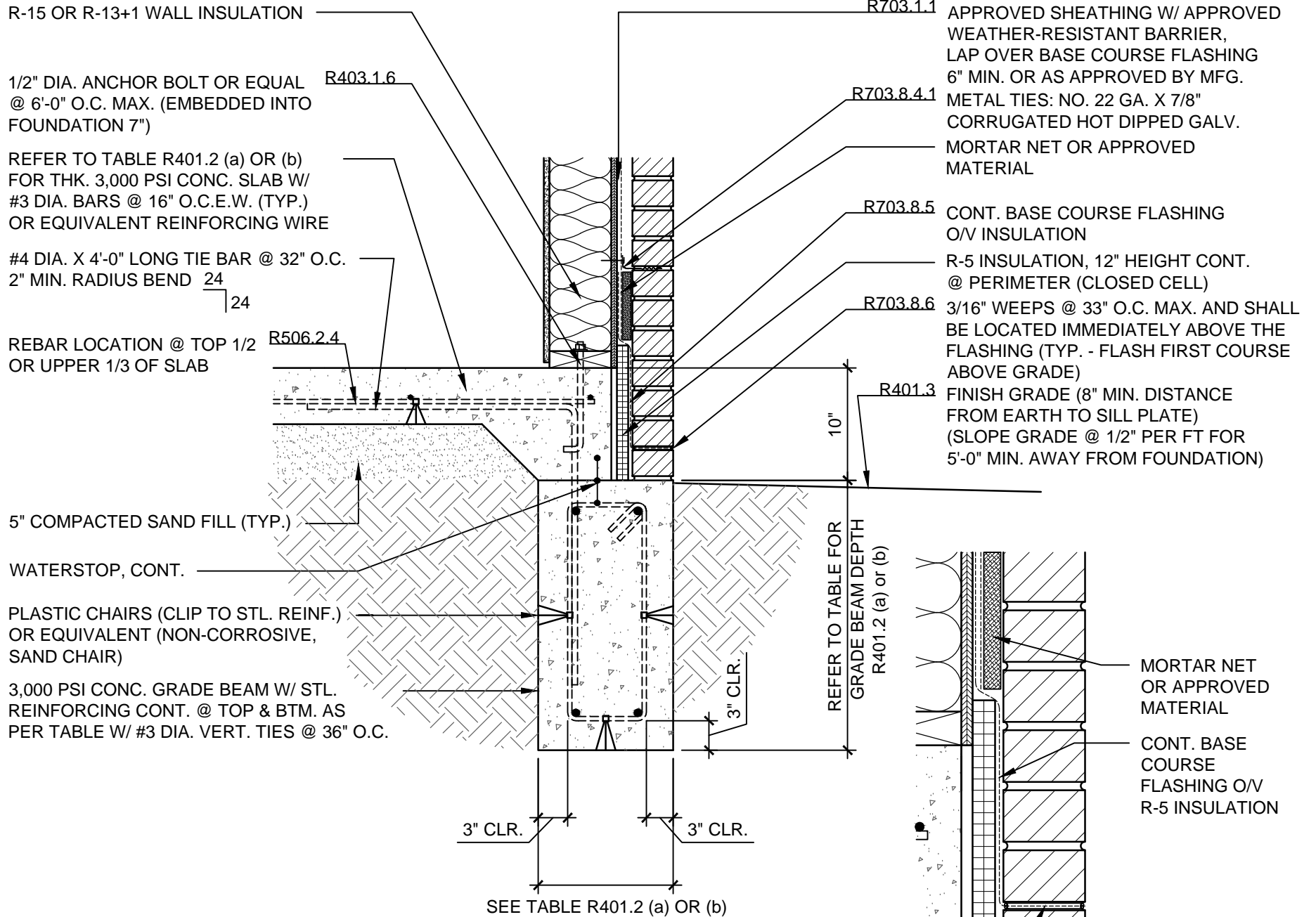

STANDARD FOUNDATION, TWO POUR

SCALE: 1" = 1'-0"

3/16" WEEPS @ 33" O.C. MAX. SHALL BE LOCATED IMMEDIATELY ABOVE THE FLASHING (TYP. - FLASH FIRST COURSE ABOVE GRADE)

1/2" DIA. ANCHOR BOLT OR EQUAL @ 6'-0" O.C. MAX. (EMBEDDED INTO FOUNDATION 7")

REFER TO TABLE R401.2 (a) OR (b) FOR THK. 3,000 PSI CONC. SLAB W/ #3 DIA. BARS @ 16" O.C.E.W. (TYP.) OR EQUIVALENT REINFORCING WIRE

#4 DIA. X 4'-0" LONG TIE BAR @ 32" O.C. 2" MIN. RADIUS BEND $\frac{24}{24}$

REBAR LOCATION @ TOP 1/2 OR UPPER 1/3 OF SLAB

5" COMPACTED SAND FILL (TYP.)

PLASTIC CHAIRS (CLIP TO STL. REINF.) OR EQUIVALENT (NON-CORROSIVE, SAND CHAIR)

3,000 PSI CONC. GRADE BEAM W/ STL. REINFORCING CONT. @ TOP & BTM. AS PER TABLE W/ #3 DIA. VERT. TIES @ 36" O.C.

R403.1.6

R506.2.4

3" CLR.

3" CLR.

SEE TABLE R401.2 (a) OR (b)

R703.1.1

R703.8.4.1

R703.8.5

R703.8.6

R401.3

APPROVED SHEATHING W/ APPROVED WEATHER-RESISTANT BARRIER, LAP OVER BASE COURSE FLASHING 6" MIN. OR AS APPROVED BY MFG.

METAL TIES: NO. 22 GA. X 7/8" CORRUGATED HOT DIPPED GALV. MORTAR NET OR APPROVED MATERIAL

CONT. BASE COURSE FLASHING O/V INSULATION

R-5 INSULATION, 12" HEIGHT CONT. @ PERIMETER (CLOSED CELL)

3/16" WEEPS @ 33" O.C. MAX. AND SHALL BE LOCATED IMMEDIATELY ABOVE THE FLASHING (TYP. - FLASH FIRST COURSE ABOVE GRADE)

FINISH GRADE (8" MIN. DISTANCE FROM EARTH TO SILL PLATE) (SLOPE GRADE @ 1/2" : FT FOR 5'-0" MIN. AWAY FROM FOUNDATION)

REFER TO TABLE FOR GRADE BEAM DEPTH R401.2(a) or (b)

STANDARD FOUNDATION, MONOLITHIC

SCALE: 1" = 1'-0"

REFER TO TABLE R401.2 (a) OR (b)
 FOR THK. 3,000 PSI CONC. SLAB W/
 #3 DIA. BARS @ 16" O.C.E.W. (TYP.)
 OR EQUIVALENT REINFORCING WIRE

REBAR LOCATION @ TOP 1/2 OR UPPER
 1/3 OF SLAB

PLASTIC CHAIRS (CLIP TO STL. REINF.)
 OR EQUIVALENT (NON-CORROSIVE,
 SAND CHAIR)

5" COMPACTED SAND FILL (TYP.)

STL. REINFORCING BARS PER
 TABLE R401.2 (a) or (b)

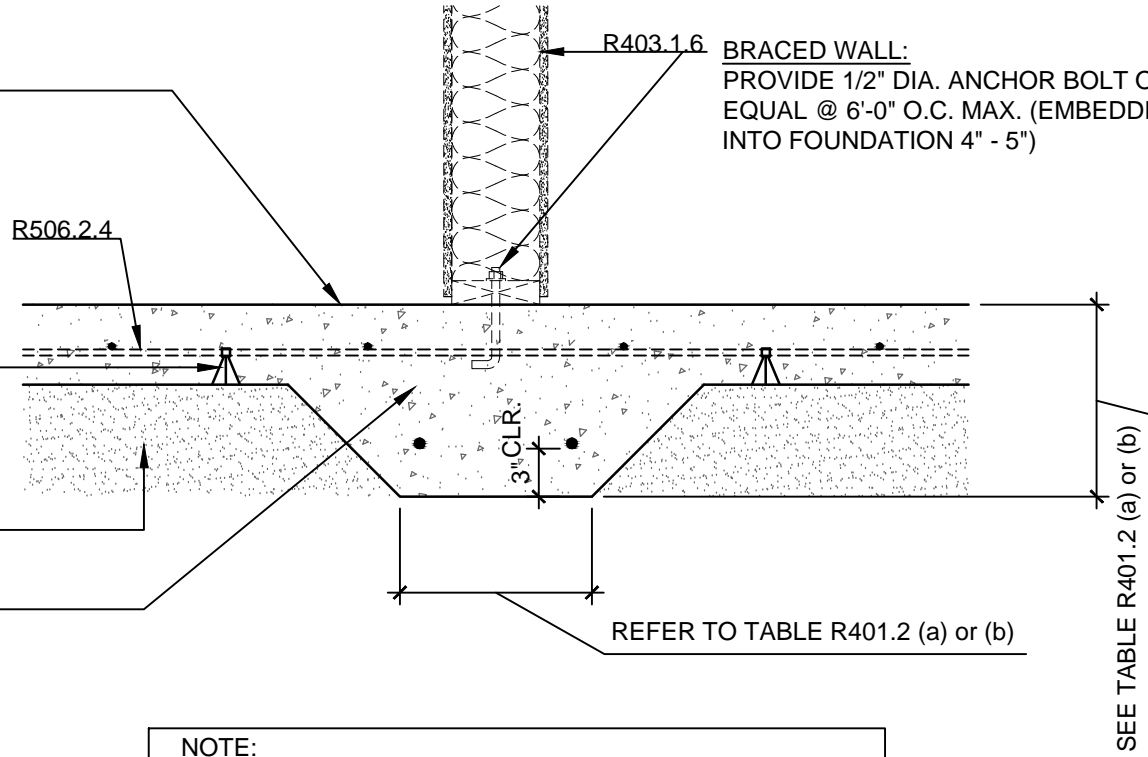

BRACED WALL:
 PROVIDE 1/2" DIA. ANCHOR BOLT OR
 EQUAL @ 6'-0" O.C. MAX. (EMBEDDED
 INTO FOUNDATION 4" - 5")

R506.2.4

R403.1.6

3" CLR.

REFER TO TABLE R401.2 (a) or (b)

SEE TABLE R401.2 (a) or (b)

NOTE:
 MUST BE INSTALLED AT MAX. INTERVALS AS PER
 R401.2 (a) or (b) AND/OR UNDER LOAD-BEARING WALLS

INTERIOR FOUNDATION BEAM

SCALE: 1" = 1'-0"

REFER TO TABLE R401.2 (a) OR (b)
 FOR THK. 3,000 PSI CONC. SLAB W/
 #3 DIA. BARS @ 16" O.C.E.W. (TYP.)
 OR EQUIVALENT REINFORCING WIRE

5" COMPACTED SAND FILL (TYP.)

#4 DIA. X 4'-0" LONG TIE BAR @ 24" O.C.
 2" MIN. RADIUS BEND $\frac{24}{24}$

#3 DIA. STIRRUP @ 12" O.C.

PLASTIC CHAIRS (CLIP TO STL. REINF.)
 OR EQUIVALENT (NON-CORROSIVE,
 SAND CHAIR)

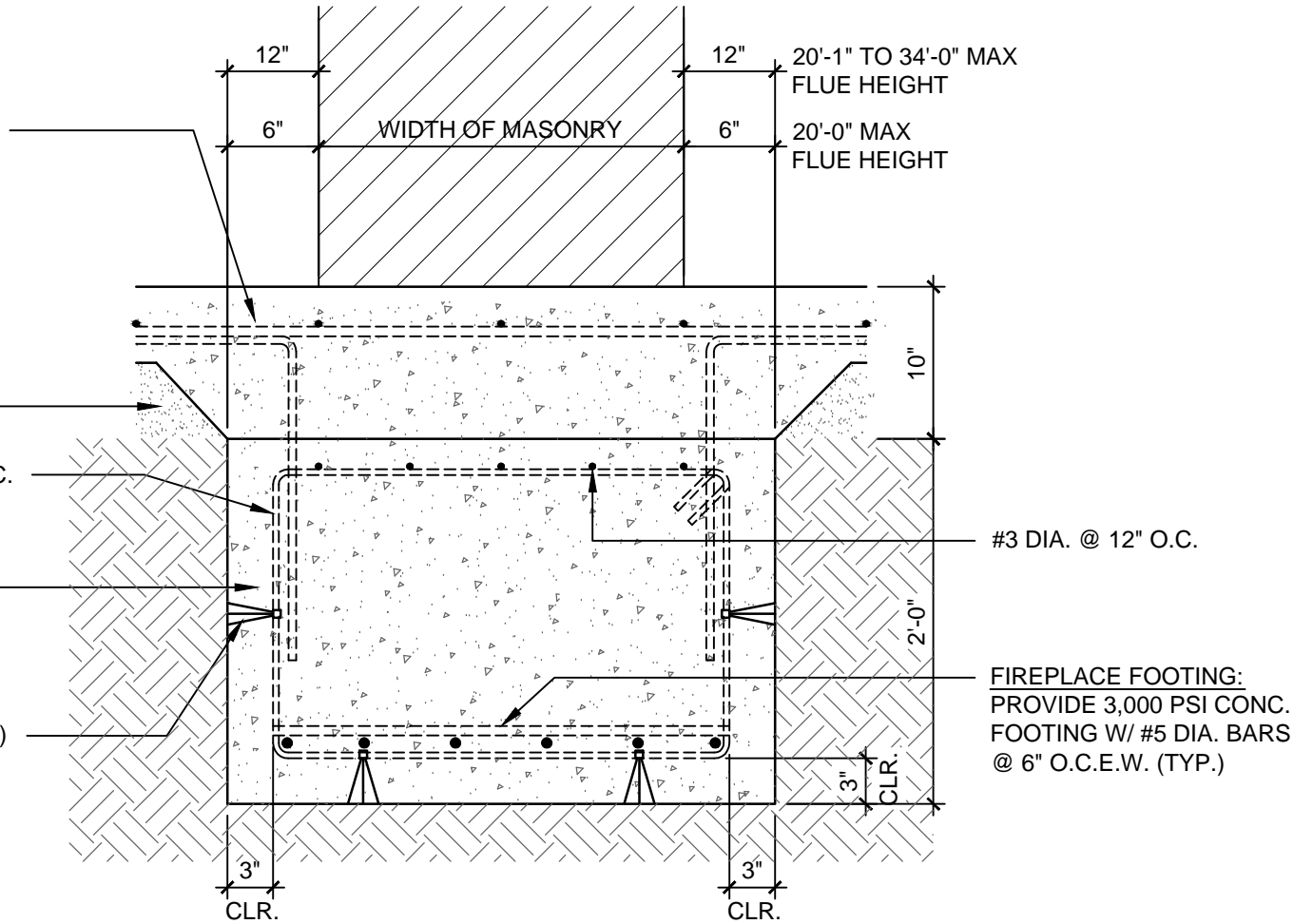

#3 DIA. @ 12" O.C.

FIREPLACE FOOTING:
 PROVIDE 3,000 PSI CONC.
 FOOTING W/ #5 DIA. BARS
 @ 6" O.C.E.W. (TYP.)

NOTE:
 R1003.9 TERMINATIONS, CHIMNEY HEIGHT
 REQUIREMENT

FIREPLACE FOOTING

SCALE: 1" = 1'-0"

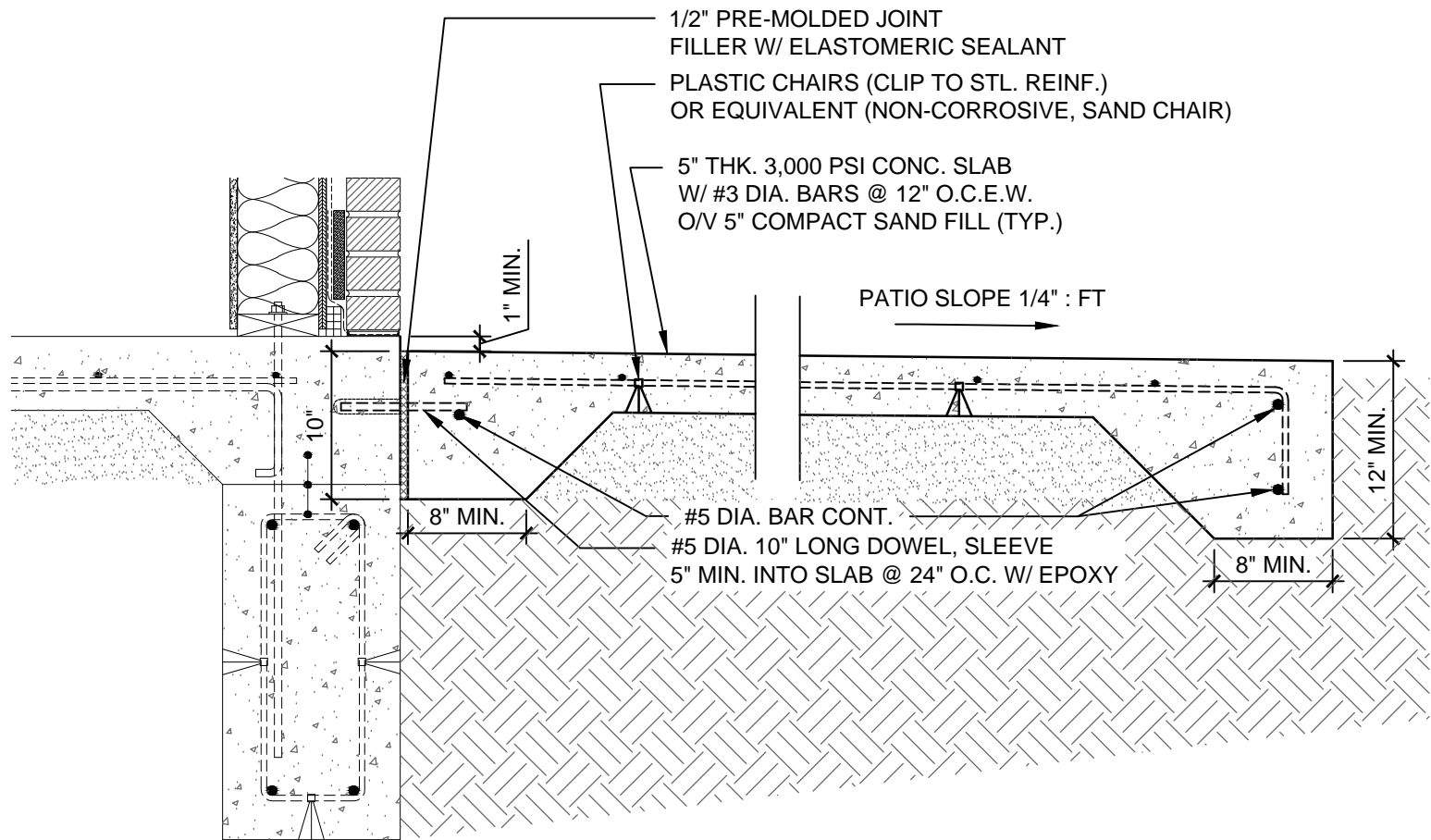

EXTERIOR GRADE BEAM TO PATIO

SCALE: 1" = 1'-0"

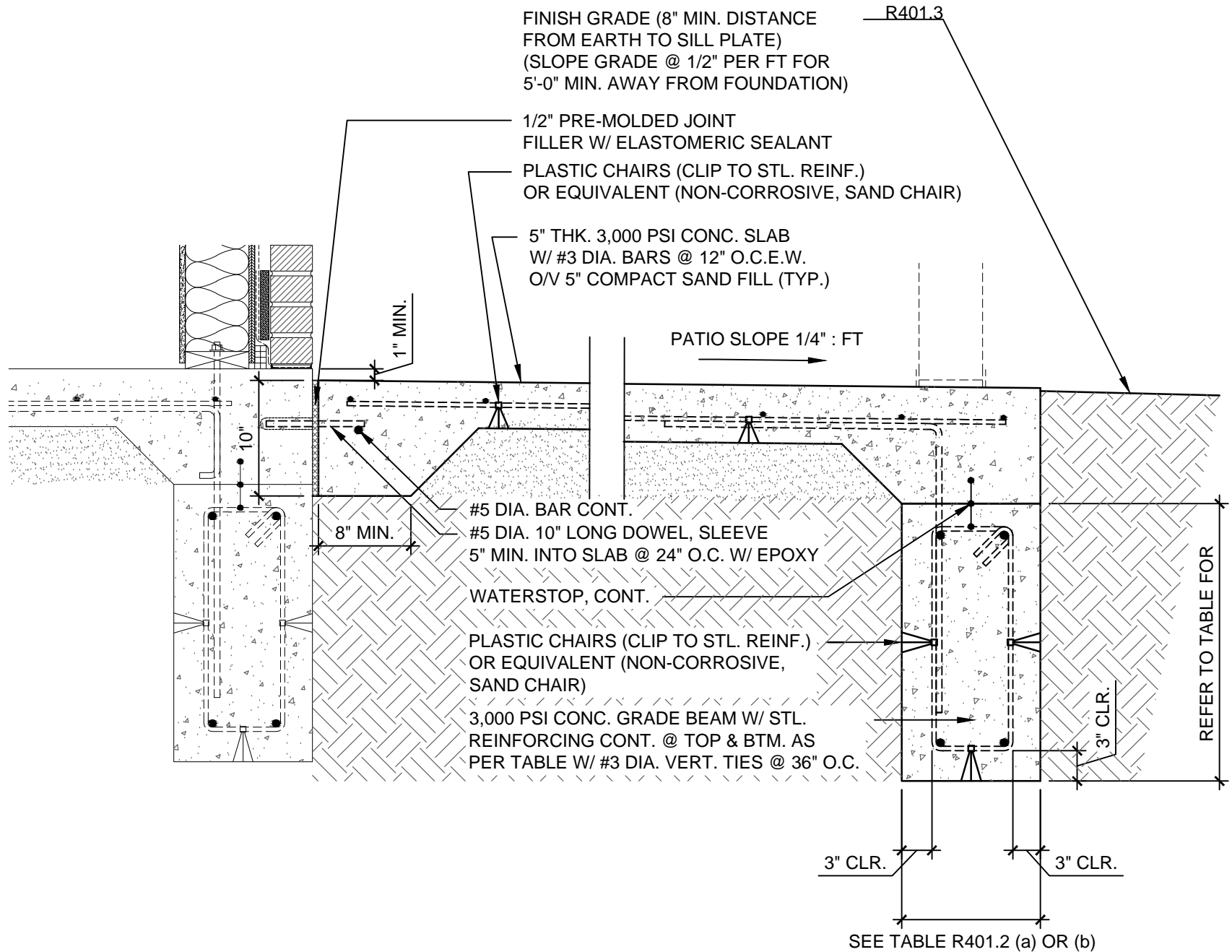

EXTERIOR GRADE BEAM TO PATIO (W/ LOAD)

SCALE: 1" = 1'-0"

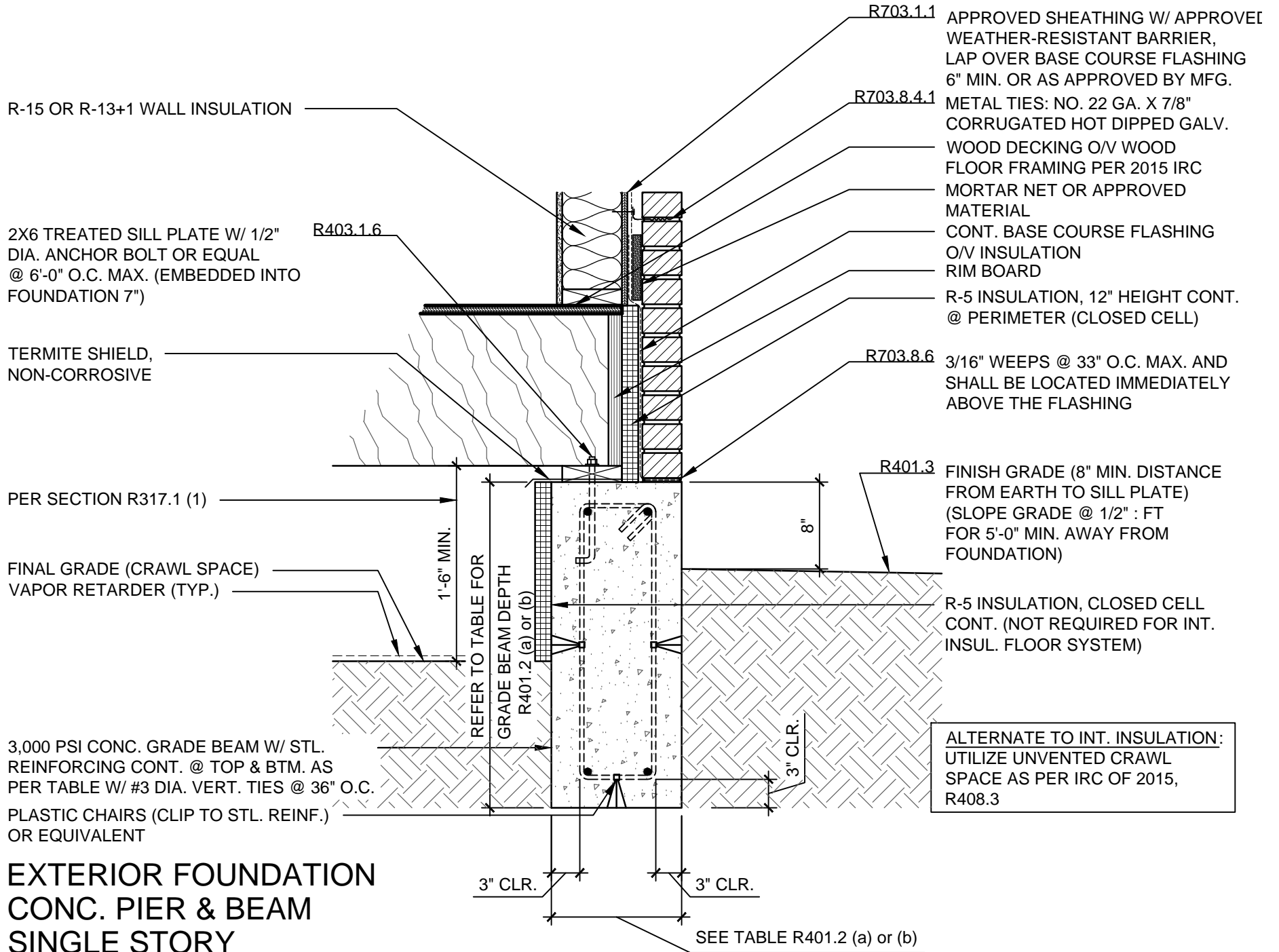

ALTERNATE TO INT. INSULATION:
UTILIZE UNVENTED CRAWL
SPACE AS PER IRC OF 2015,
R408.3

EXTERIOR FOUNDATION CONC. PIER & BEAM SINGLE STORY

SCALE: 1" = 1'-0"

R-15 OR R-13+1 WALL INSULATION

2X6 TREATED SILL PLATE W/ 1/2" DIA. ANCHOR BOLT OR EQUAL @ 6'-0" O.C. MAX. (EMBEDDED INTO FOUNDATION 7")

TERMITE SHIELD, NON-CORROSIVE

PER SECTION R317.1 (1)
PLASTIC CHAIRS (CLIP TO STL. REINF.) OR EQUIVALENT
FINAL GRADE (CRAWL SPACE)
VAPOR RETARDER (TYP.)

3,000 PSI CONC. GRADE BEAM W/ STL. REINFORCING CONT. @ TOP & BTM. AS PER TABLE W/ #3 DIA. VERT. TIES @ 36" O.C.

EXTERIOR FOUNDATION CONC. PIER & BEAM TWO STORY

SCALE: 1" = 1'-0"

R403.1.6

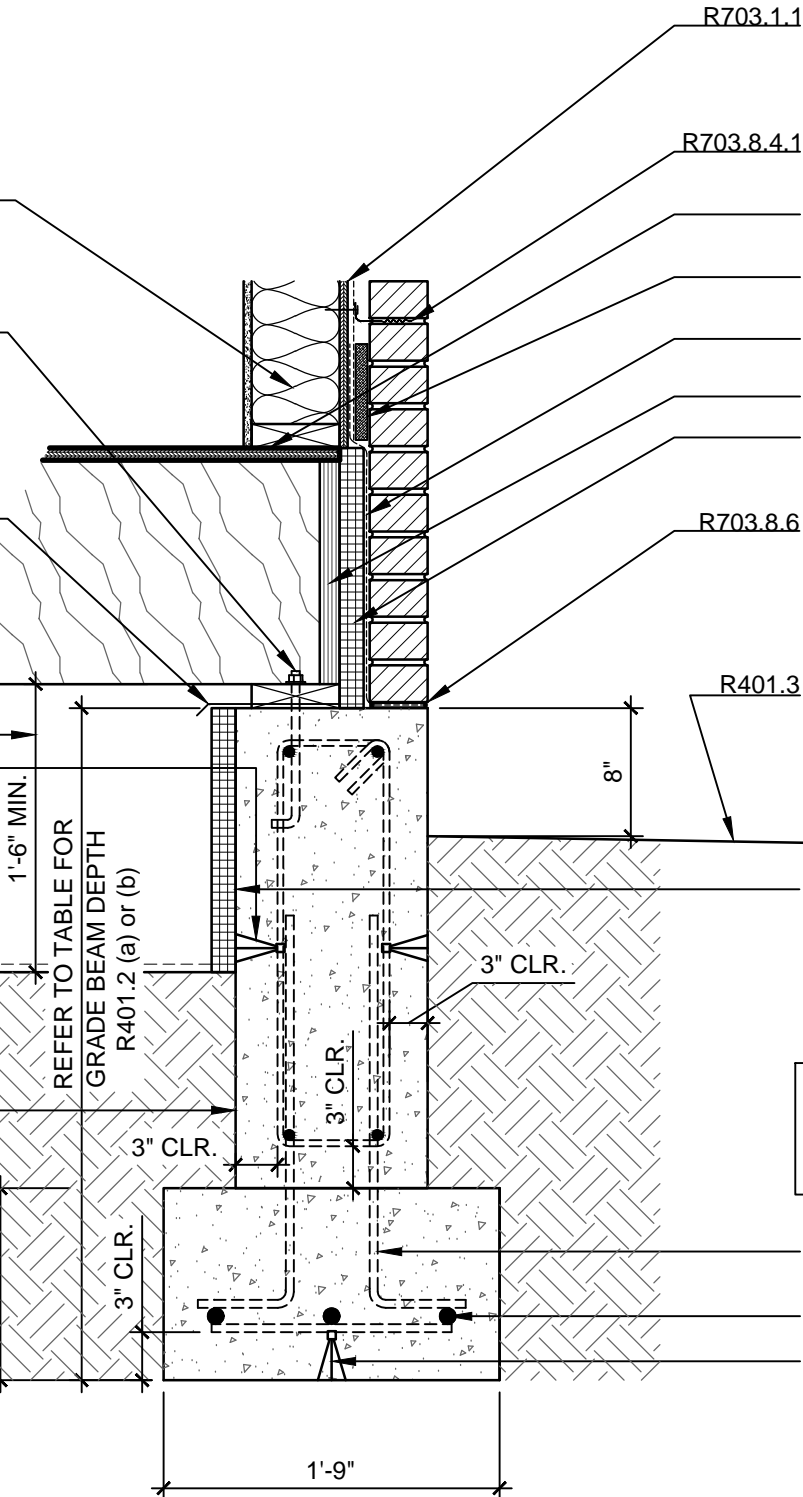

R703.1.1

APPROVED SHEATHING W/ APPROV. WEATHER-RESISTANT BARRIER, LAP OVER BASE COURSE FLASHING 6" MIN. OR AS APPROVED BY MFG.

R703.8.4.1

METAL TIES: NO. 22 GA. X 7/8" CORRUGATED HOT DIPPED GALV. WOOD DECKING O/V WOOD FLOOR FRAMING PER 2015 IRC MORTAR NET OR APPROVED MATERIAL

CONT. BASE COURSE FLASHING O/V INSULATION RIM BOARD

R-5 INSULATION, 12" HEIGHT CONT. @ PERIMETER (CLOSED CELL)

R703.8.6

3/16" WEEPS @ 33" O.C. MAX. AND SHALL BE LOCATED IMMEDIATELY ABOVE THE FLASHING

R401.3

FINISH GRADE (8" MIN. DISTANCE FROM EARTH TO SILL PLATE) (SLOPE GRADE @ 1/2" : FT FOR 5'-0" MIN. AWAY FROM FOUNDATION)

R-5 INSULATION, CONT. @ PERIMETER W/ SELF ADHERED WATERPROOFING EXTENDED O/V ENTIRE SURFACE (NOT REQUIRED FOR INT. INSUL. FLOOR SYSTEM)

ALTERNATE TO INT. INSULATION:
UTILIZE UNVENTED CRAWL SPACE AS PER IRC OF 2015, R408.3

#5 DIA. BARS 10"X24" DOWELS @ 24" O.C. (ALT. DIRECTION)
#5 DIA. @ 18" O.C. W/ (3) #5 DIA.

PLASTIC CHAIRS (CLIP TO STL. REINF. OR EQUIVALENT (NON-CORROSIVE, SAND CHAIR))

EXTERIOR FOUNDATION 12" CMU STEM WALL SINGLE STORY

SCALE: 1" = 1'-0"

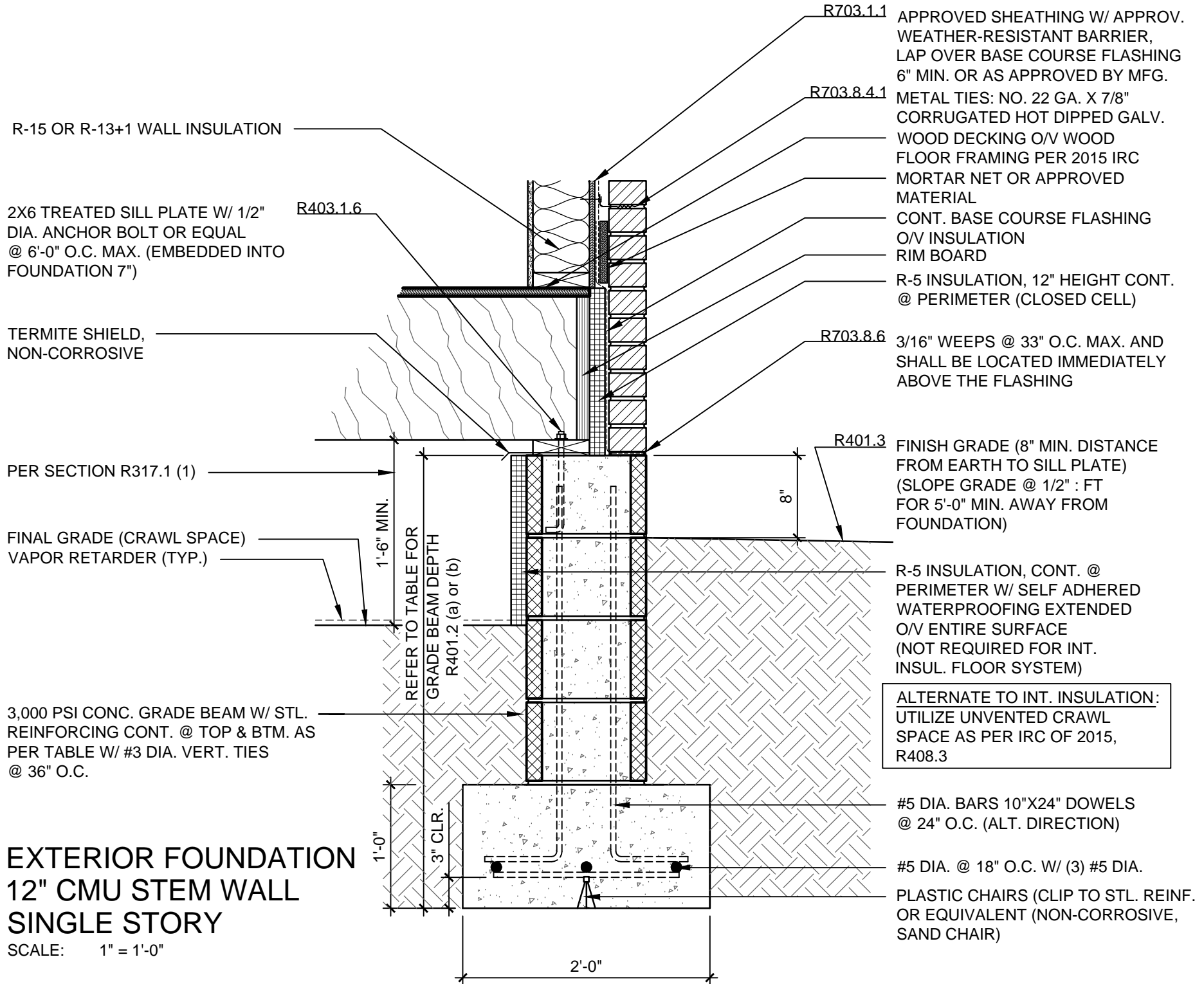

FOR (2) 2X6 GIRDERS ONLY:

PIER DIA.	SPACING
12"	PIERS SHALL BE LOCATED @ 5'-0" O.C. IN EACH DIRECTION

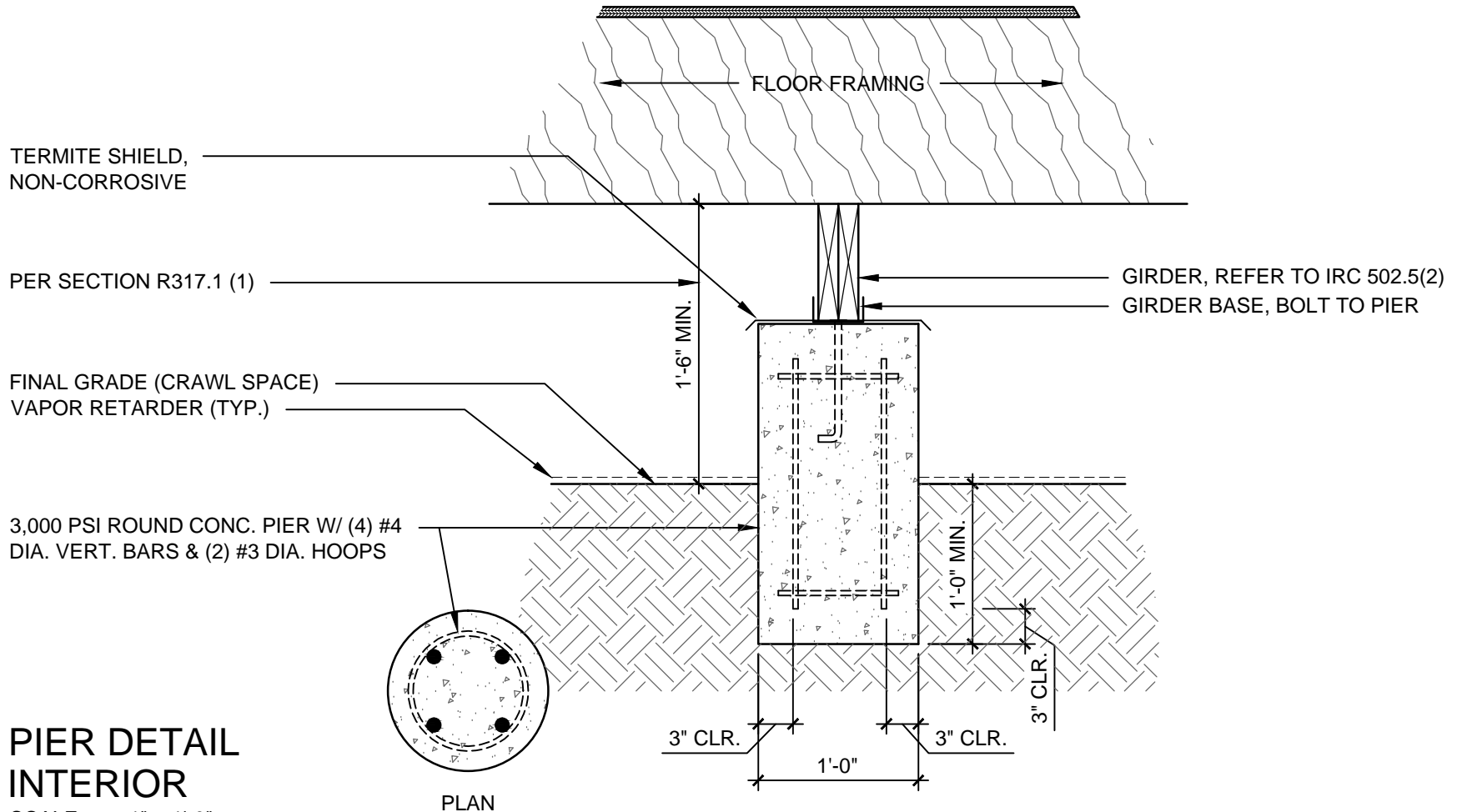

PIER DETAIL INTERIOR

SCALE: 1" = 1'-0"

TABLE 401.1.2 (c)			
CLEAR SPAN OF ROOF SLAB	SLAB THICKNESS	REQUIRED REINFORCEMENT	
		LS	LL
6'-0"	5"	#4 @ 6" O.C.	#3 @ 10" O.C.
8'-0"	5"	#4 @ 6" O.C.	#3 @ 10" O.C.
10'-0"	5"	#4 @ 6" O.C.	#3 @ 10" O.C.
12'-0"	6"	#5 @ 8" O.C.	#4 @ 16" O.C.
14'-0"	7"	#5 @ 6" O.C.	#4 @ 12" O.C.
16'-0"	8"	#5 @ 6" O.C.	#4 @ 12" O.C.
18'-0"	9"	#6 @ 8" O.C.	#4 @ 10" O.C.
20'-0"	10"	#6 @ 6" O.C.	#4 @ 10" O.C.

GENERAL NOTES

GRADE 60 REINFORCING STEEL. BOTTOM BARS TO RUN SHORT WAY WITH 3/4" CLEAR BELOW BARS IN ALL CASES.

3,000 PSI MIN. CONCRETE STRENGTH REQUIRED.

DESIGN LOADS ASSUMED: 100 PSF LIVE LOAD AND 20 PSF PARTITION LOAD.

NO BEARING WALLS SHALL OCCUR ON BASEMENT ROOF SLAB

BASEMENT MAY NOT BE USED AS SLEEPING AREAS UNLESS EMERGENCY ESCAPE OPENINGS ARE PROVIDED ACCORDING TO IRC SECTION 310.

MAXIMUM LENGTH OF STAIR OPENING IN ROOF SLAB SHALL BE 13'-0". OPENINGS SHALL HAVE STEEL SUPPORT BEAM (W12X26, W10X30, OR W8X40) ON ALL SIDES WHERE NO BEARING WALL OCCURS: OPENINGS SHALL HAVE A 3" STANDARD PIPE COLUMN WITH CONCRETE FOOTINGS AT ALL STEEL BEAM INTERSECTIONS.

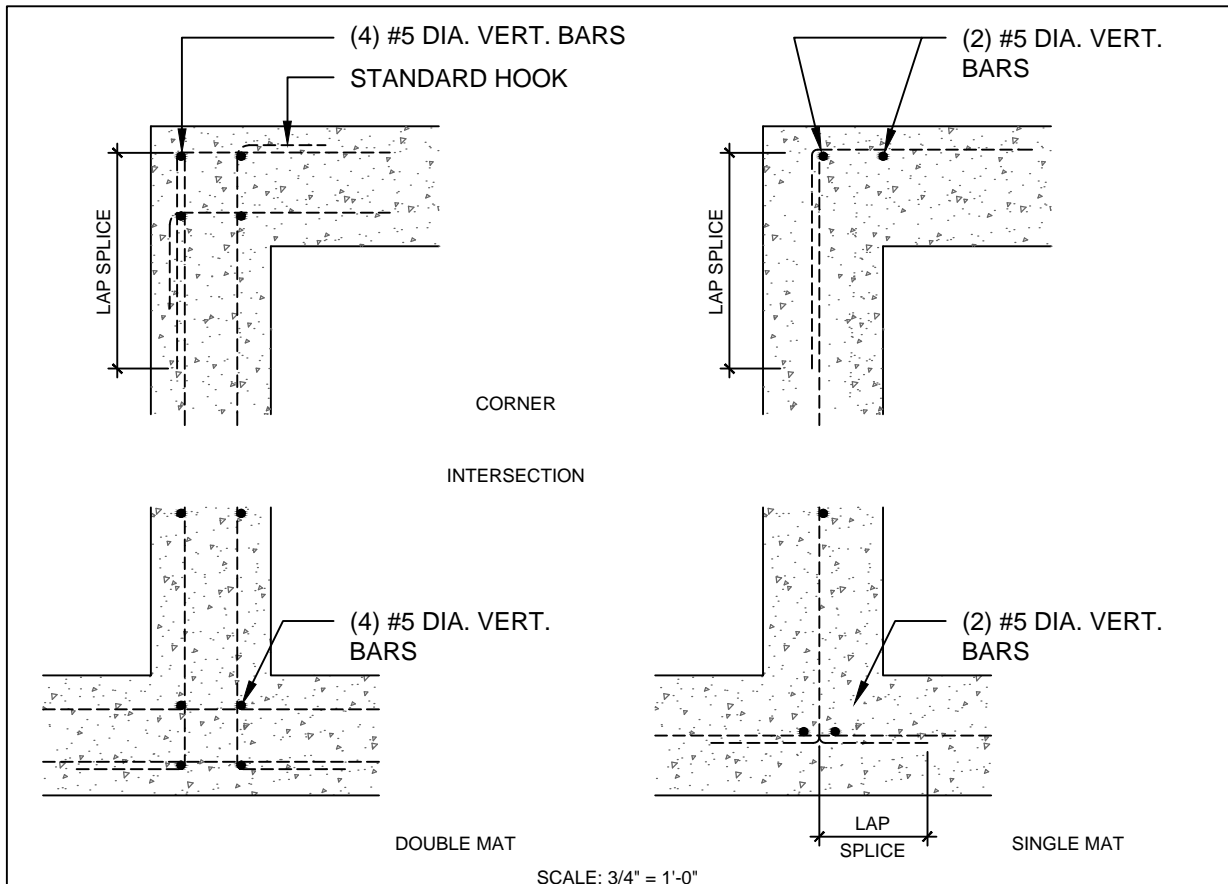

REINFORCING AT WALL INTERSECTIONS

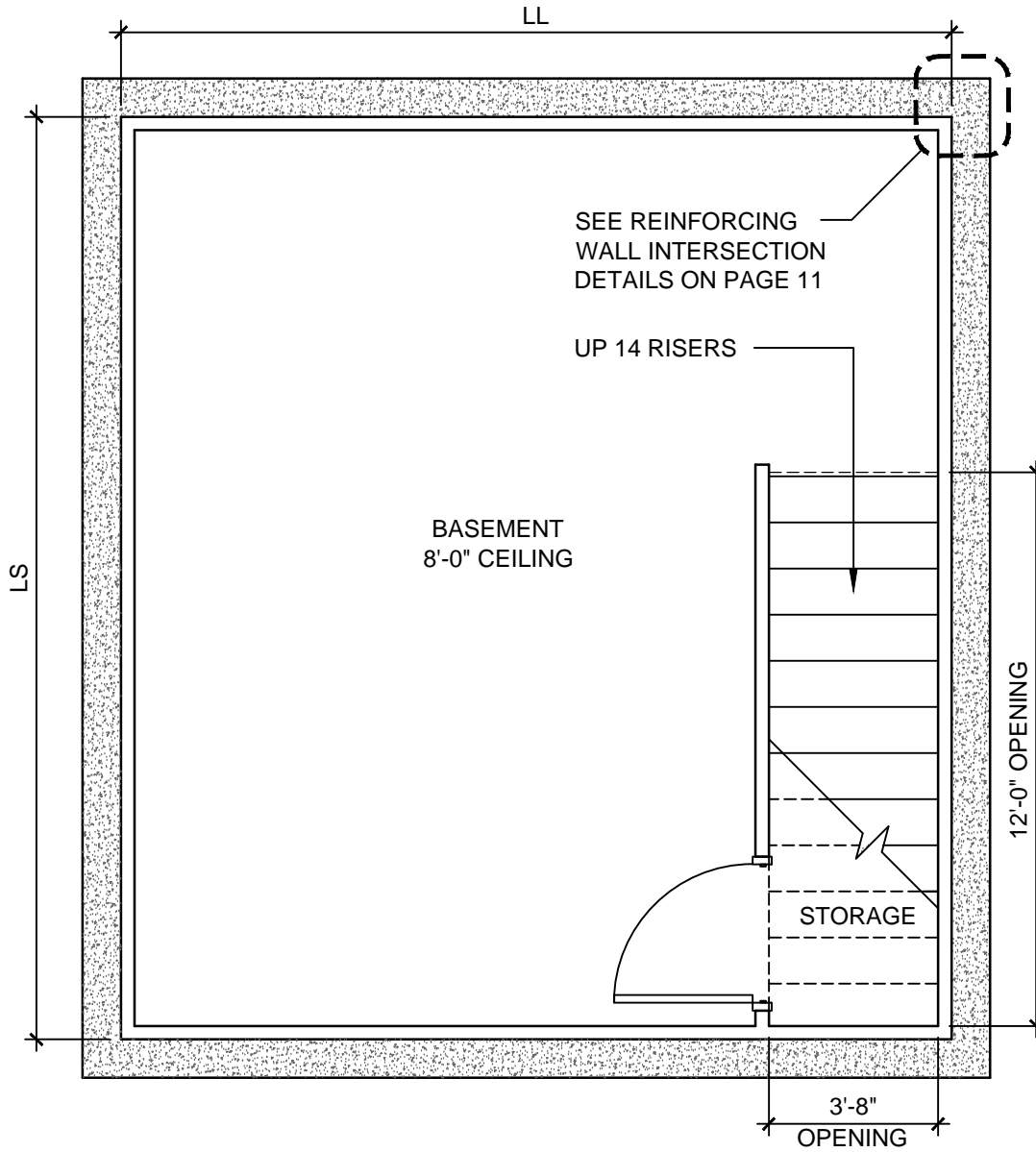

BASEMENT FLOOR PLAN

SCALE: 1/4" = 1'-0"

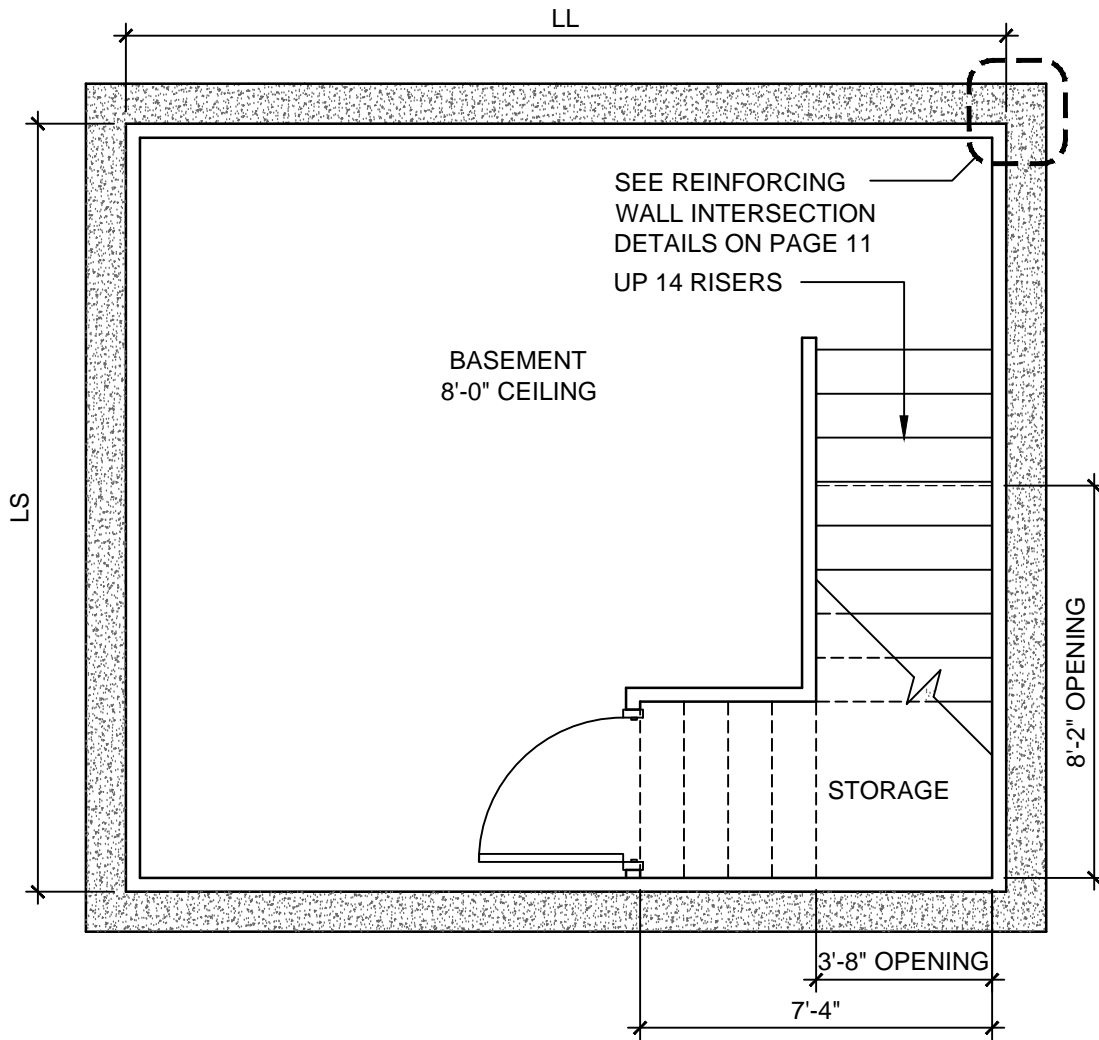

BASEMENT FLOOR PLAN

SCALE: 1/4" = 1'-0"

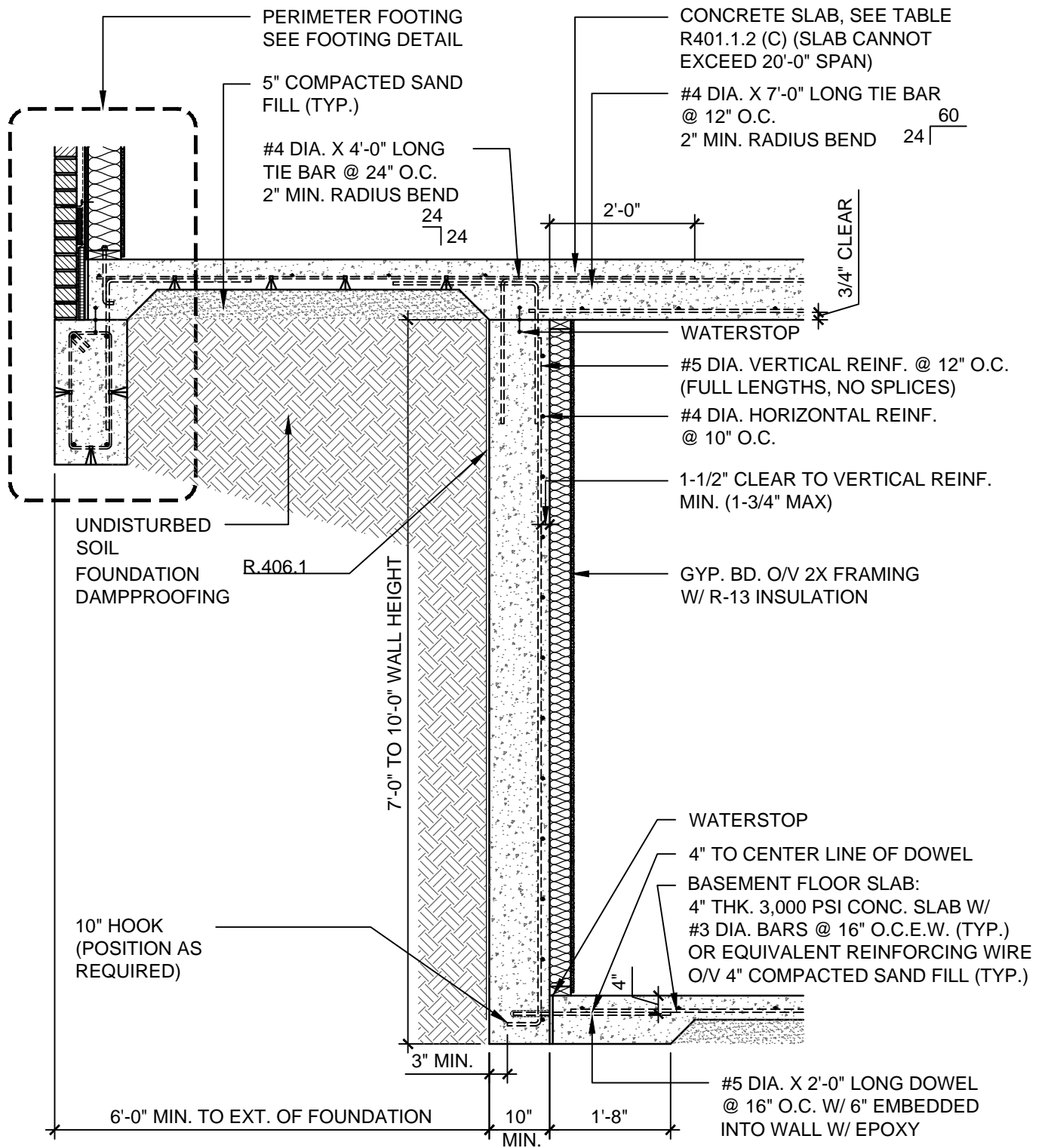

NOTE:
SEE REINFORCING WALL INTERSECTION DETAILS ON PAGE 11

TRENCHED BASEMENT WALL DETAIL

SCALE: 1/2" = 1'-0"

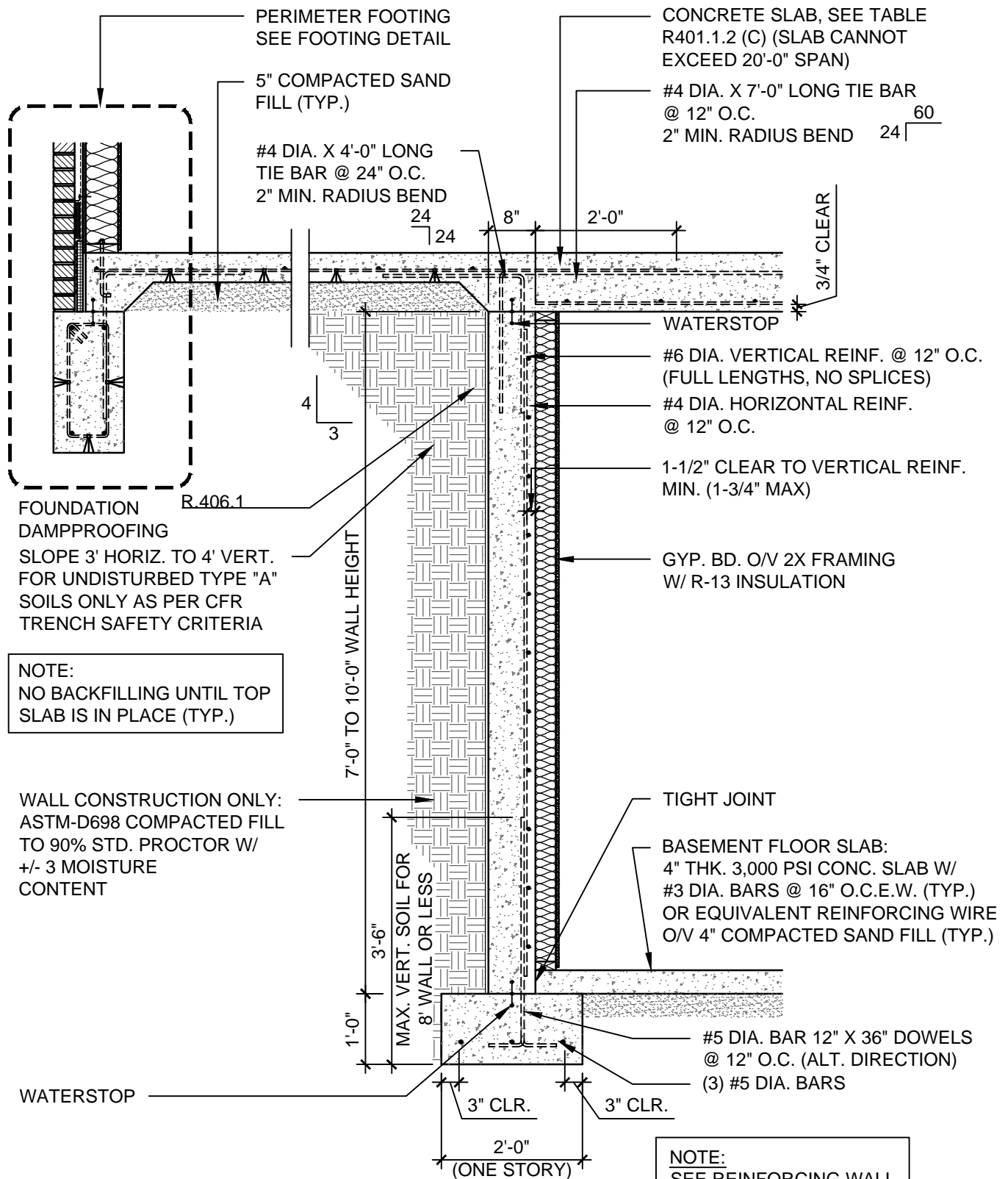

NOTE:
SEE REINFORCING WALL INTERSECTION DETAILS ON PAGE 11

8" FORMED BASEMENT WALL DETAIL

SCALE: 1/2" = 1'-0"

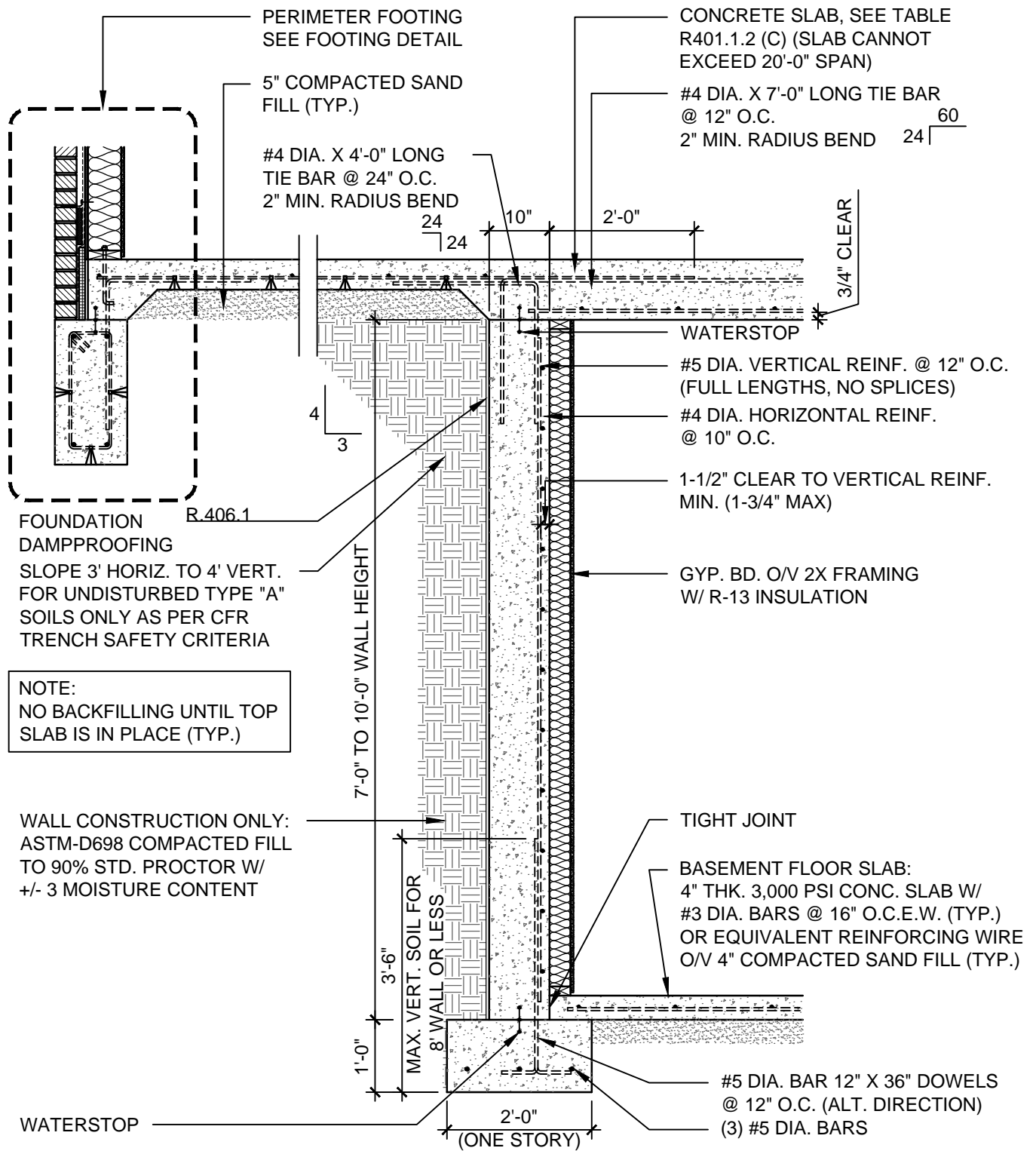

NOTE:
SEE REINFORCING WALL
INTERSECTION DETAILS
ON PAGE 11

10" FORMED BASEMENT WALL DETAIL

SCALE: 1/2" = 1'-0"

22GA. PRE-FINISHED METAL OR STUCCO O/V INSULATION
 R-5 INSULATION, CONT. @ PERIMETER W/ SELF ADHERED WATERPROOFING EXTENDED O/V ENTIRE SURFACE (CLOSED CELL)
 DRAINAGE BOARD SYSTEM
 FINISH GRADE (8" MIN. DISTANCE FROM EARTH TO SILL PLATE) (SLOPE GRADE @ 1/2" : FT FOR 5'-0" MIN. AWAY FROM FOUNDATION)

SLOPE 3' HORIZ. TO 4' VERT. FOR UNDISTURBED TYPE "A" SOILS ONLY AS PER CFR TRENCH SAFETY CRITERIA

FOUNDATION DAMPPROOFING

WALL CONSTRUCTION ONLY: ASTM-D698 COMPACTED FILL TO 90% STD. PROCTOR W/ +/- 3 MOISTURE CONTENT

NOTE:
 NO BACKFILLING UNTIL TOP SLAB IS IN PLACE (TYP.)

WATERSTOP
 4" PERFORATED PVC PIPE W/ WELL GRADED GRAVEL

FILTER FABRIC @ TOP & SIDE OF GRAVEL

(3) #5 DIA. BARS
 3" CLR.

2'-0"
 (ONE STORY)
 2'-6"
 (TWO STORY)
 (4) #5 DIA. BARS

R-5 INSULATION, CONT. BEHIND SIDING
 R-15 OR R-13+1 WALL INSULATION
 CONCRETE SLAB, SEE TABLE R401.2 (C) (SLAB CANNOT EXCEED 20'-0" SPAN)
 #4 DIA. X 7'-0" LONG TIE BAR @ 12" O.C.
 2" MIN. RADIUS BEND

WATERSTOP
 #6 DIA. VERTICAL REINF. @ 12" O.C. (FULL LENGTHS, NO SPLICES)
 #4 DIA. HORIZONTAL REINF. @ 12" O.C.
 1-1/2" CLEAR TO VERTICAL REINF. MIN. (1-3/4" MAX)

GYP. BD. O/V 2X FRAMING W/ R-13 INSULATION

TIGHT JOINT
 #5 DIA. BAR 12" X 36" DOWELS @ 12" O.C. (ALT. DIRECTION)
 BASEMENT FLOOR SLAB: 4" THK. 3,000 PSI CONC. SLAB W/ #3 DIA. BARS @ 16" O.C.E.W. (TYP.) OR EQUIVALENT REINFORCING WIRE O/V 4" COMPACTED SAND FILL (TYP.)

SUMP PUMP (REFER TO MANUFACTURER REQUIREMENTS)

NOTE:
 SEE REINFORCING WALL INTERSECTION DETAILS ON PAGE 11

8" FORMED BASEMENT PERIMETER WALL DETAIL W/ SIDING
 SCALE: 1/2" = 1'-0"

22GA. PRE-FINISHED METAL OR STUCCO O/V INSULATION
 R-10 INSULATION, CONT. @ PERIMETER W/ SELF ADHERED WATERPROOFING EXTENDED O/V ENTIRE SURFACE (CLOSED CELL)
 DRAINAGE BOARD SYSTEM
 FINISH GRADE (8" MIN. DISTANCE FROM EARTH TO SILL PLATE) (SLOPE GRADE @ 1/2" : FT FOR 5'-0" MIN. AWAY FROM FOUNDATION)

SLOPE 3' HORIZ. TO 4' VERT. FOR UNDISTURBED TYPE "A" SOILS ONLY AS PER CFR TRENCH SAFETY CRITERIA

FOUNDATION DAMPPROOFING

WALL CONSTRUCTION ONLY: ASTM-D698 COMPACTED FILL TO 90% STD. PROCTOR W/ +/- 3 MOISTURE CONTENT

NOTE:
 NO BACKFILLING UNTIL TOP SLAB IS IN PLACE (TYP.)

WATERSTOP
 4" PERFORATED PVC PIPE W/ WELL GRADED GRAVEL

FILTER FABRIC @ TOP & SIDE OF GRAVEL

(3) #5 DIA. BARS
 3" CLR.
 2'-0" (ONE STORY)
 2'-6" (TWO STORY)
 (4) #5 DIA. BARS
 3" CLR.

10" FORMED BASEMENT PERIMETER WALL DETAIL W/ SIDING

SCALE: 1/2" = 1'-0"

R-5 INSULATION, CONT. BEHIND SIDING
 R-15 OR R-13+1 WALL INSULATION
 CONCRETE SLAB, SEE TABLE R401.1.2 (C) (SLAB CANNOT EXCEED 20'-0" SPAN)
 #4 DIA. X 7'-0" LONG TIE BAR @ 12" O.C.
 2" MIN. RADIUS BEND 24 60

WATERSTOP
 #5 DIA. VERTICAL REINF. @ 12" O.C. (FULL LENGTHS, NO SPLICES)
 #4 DIA. HORIZONTAL REINF. @ 10" O.C.
 1-1/2" CLEAR TO VERTICAL REINF. MIN. (1-3/4" MAX)

GYP. BD. O/V 2X FRAMING W/ R-13 INSULATION

TIGHT JOINT
 #5 DIA. BAR 12" X 36" DOWELS @ 12" O.C. (ALT. DIRECTION)
 BASEMENT FLOOR SLAB: 4" THK. 3,000 PSI CONC. SLAB W/ #3 DIA. BARS @ 16" O.C.E.W. (TYP.) OR EQUIVALENT REINFORCING WIRE O/V 4" COMPACTED SAND FILL (TYP.)

SUMP PUMP (REFER TO MANUFACTURER REQUIREMENTS)

NOTE:
 SEE REINFORCING WALL INTERSECTION DETAILS ON PAGE 11

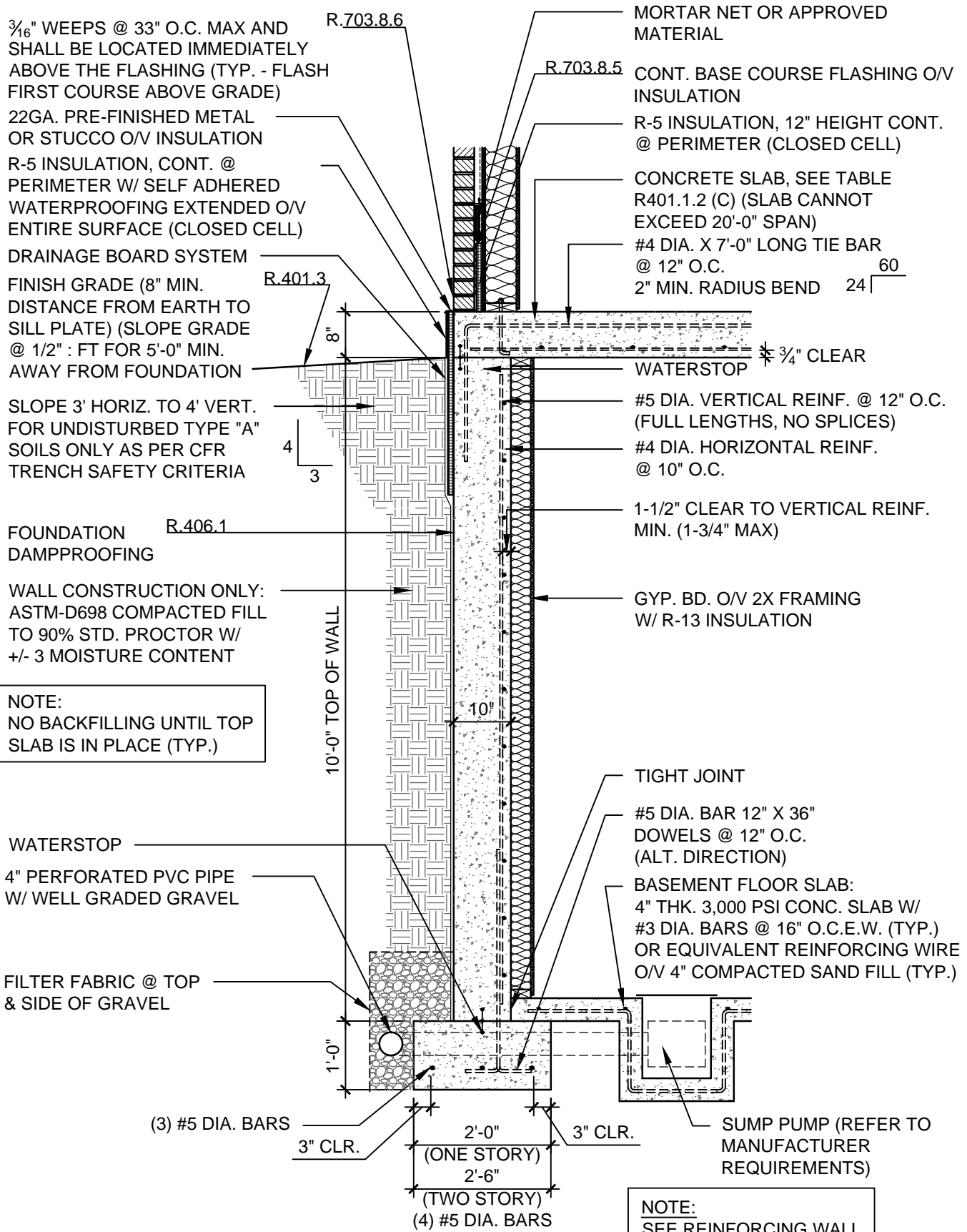

10" FORMED BASEMENT PERIMETER WALL DETAIL W/ BRICK
 SCALE: 1/2" = 1'-0"

NOTE:
 SEE REINFORCING WALL INTERSECTION DETAILS ON PAGE 11

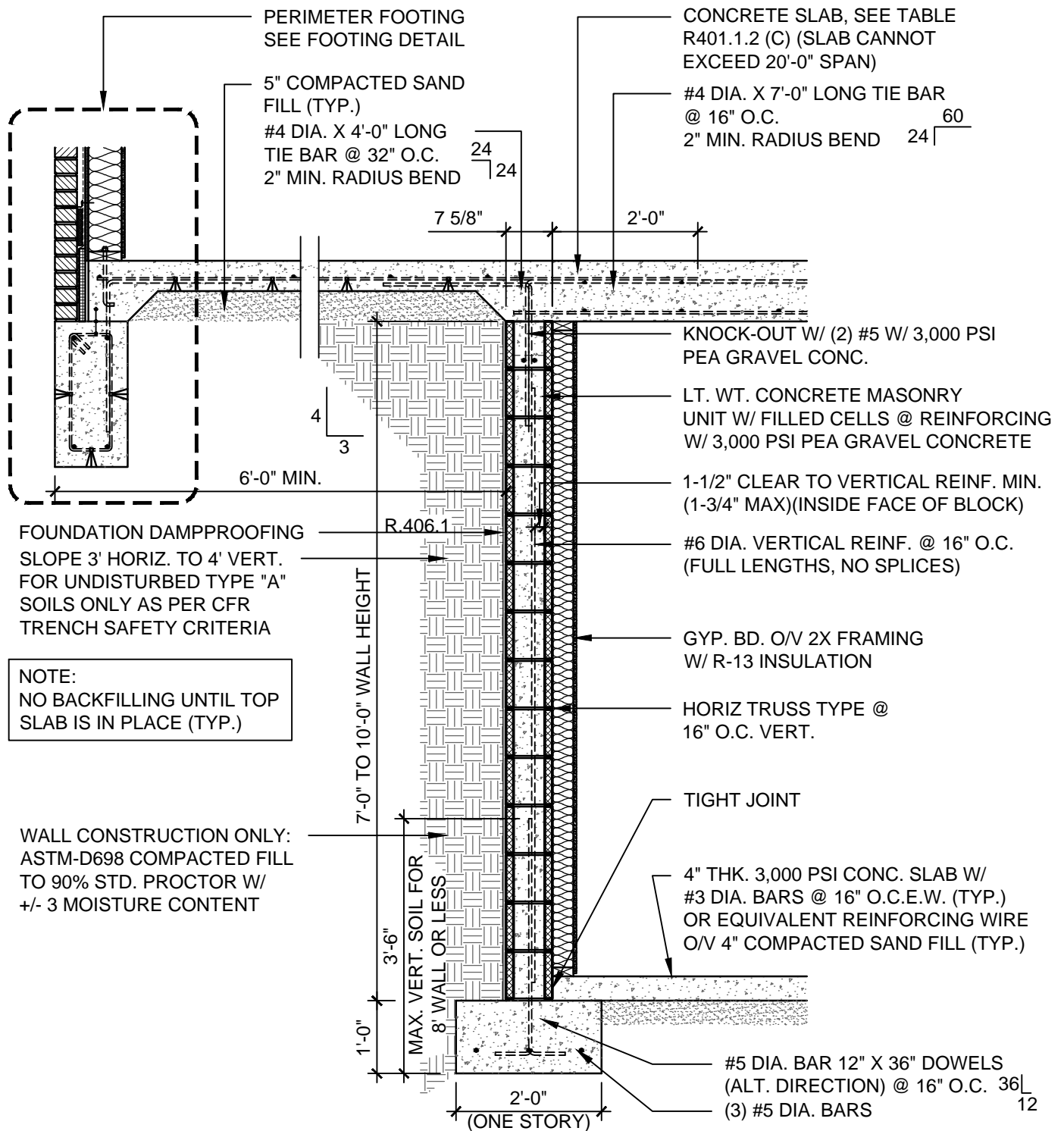

8" CMU BASEMENT WALL DETAIL

SCALE: 1/2" = 1'-0"

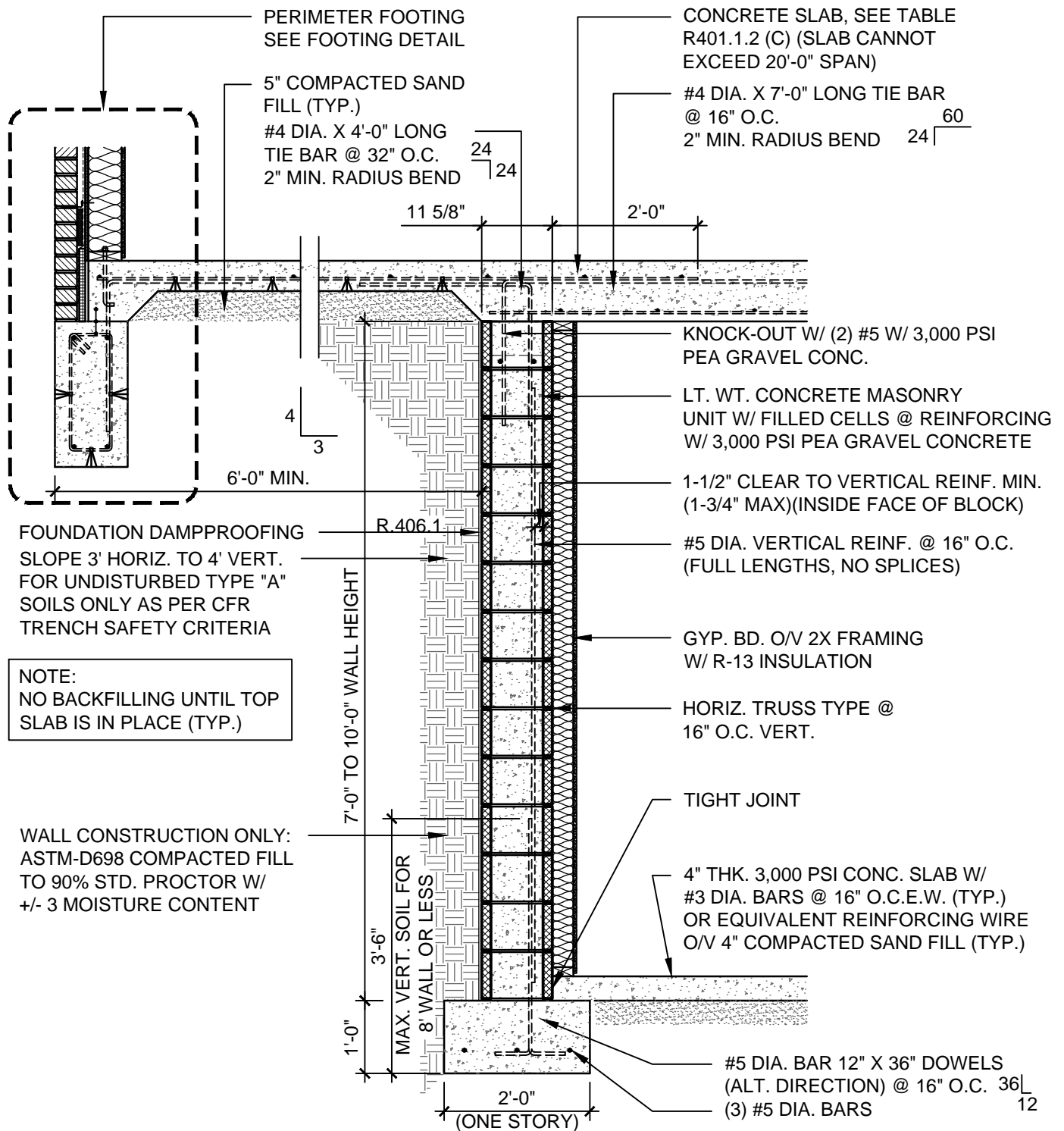

12" CMU BASEMENT WALL DETAIL

SCALE: 1/2" = 1'-0"

22 GA. PRE-FINISHED METAL OR STUCCO O/V INSULATION
 R-5 INSULATION, CONT. @ PERIMETER W/ SELF ADHERED WATERPROOFING EXTENDED O/V ENTIRE SURFACE (CLOSED CELL)

DRAINAGE BOARD SYSTEM
 FINISH GRADE (8" MIN. DISTANCE FROM EARTH TO SILL PLATE) (SLOPE GRADE @ 1/2" : FT FOR 5'-0" MIN. AWAY FROM FOUNDATION)

SLOPE 3' HORIZ. TO 4' VERT. FOR UNDISTURBED TYPE "A" SOILS ONLY AS PER CFR TRENCH SAFETY CRITERIA

FOUNDATION DAMPPROOFING WALL CONSTRUCTION ONLY: ASTM-D698 COMPACTED FILL TO 90% STD. PROCTOR W/ +/- 3 MOISTURE CONTENT

NOTE:
 NO BACKFILLING UNTIL TOP SLAB IS IN PLACE (TYP.)

R-5 INSULATION, CONT. BEHIND SIDING
 R-15 OR R-13+1 WALL INSULATION
 CONCRETE SLAB, SEE TABLE R401.1.2 (C) (SLAB CANNOT EXCEED 20'-0" SPAN)
 #4 DIA. X 7'-0" LONG TIE BAR @ 12" O.C.
 2" MIN. RADIUS BEND

R.401.3

8"

4

3

R.406.1

7'-0" TO 10'-0" WALL HEIGHT

3'-6"

1'-0"

MAX. VERT. SOIL FOR 8" WALL OR LESS

FILTER FABRIC @ TOP & SIDE OF GRAVEL
 4" PERFORATED PVC PIPE W/ WELL GRADED GRAVEL
 (3) #5 DIA. BARS

2'-0" (ONE STORY)

2'-6" (TWO STORY)

(4) #5 DIA. BARS

KNOCK-OUT W/ (2) #5 W/ 3,000 PSI PEA GRAVEL CONC.

LT. WT. CONCRETE MASONRY UNIT W/ FILLED CELLS @ REINFORCING W/ 3,000 PSI PEA GRAVEL CONCRETE

1-1/2" CLEAR TO VERTICAL REINF. MIN. (1-3/4" MAX)

#6 DIA. VERTICAL REINF. @ 16" O.C. (FULL LENGTHS, NO SPLICES)

GYP. BD. O/V 2X FRAMING W/ R-13 INSULATION

HORIZ TRUSS TYPE @ 16" O.C. VERT.

TIGHT JOINT

#5 DIA. BAR 12" X 36" DOWELS (ALT. DIRECTION) @ 16" O.C.

4" THK. 3,000 PSI CONC. SLAB W/ #3 DIA. BARS @ 16" O.C.E.W. (TYP.) OR EQUIVALENT REINFORCING WIRE O/V 4" COMPACTED SAND FILL (TYP.)

SUMP PUMP (REFER TO MANUFACTURER REQUIREMENTS)

8" CMU BASEMENT PERIMETER WALL DETAIL W/ SIDING

SCALE: 1/2" = 1'-0"

22 GA. PRE-FINISHED METAL OR STUCCO O/V INSULATION

R-5 INSULATION, CONT. @ PERIMETER W/ SELF ADHERED WATERPROOFING EXTENDED O/V ENTIRE SURFACE (CLOSED CELL)

DRAINAGE BOARD SYSTEM

FINISH GRADE (8" MIN. DISTANCE FROM EARTH TO SILL PLATE) (SLOPE GRADE @ 1/2" : FT FOR 5'-0" MIN. AWAY FROM FOUNDATION

SLOPE 3' HORIZ. TO 4' VERT. FOR UNDISTURBED TYPE "A" SOILS ONLY AS PER CFR TRENCH SAFETY CRITERIA

FOUNDATION DAMPPROOFING

WALL CONSTRUCTION ONLY: ASTM-D698 COMPACTED FILL TO 90% STD. PROCTOR W/ +/- 3 MOISTURE CONTENT

NOTE:
NO BACKFILLING UNTIL TOP SLAB IS IN PLACE (TYP.)

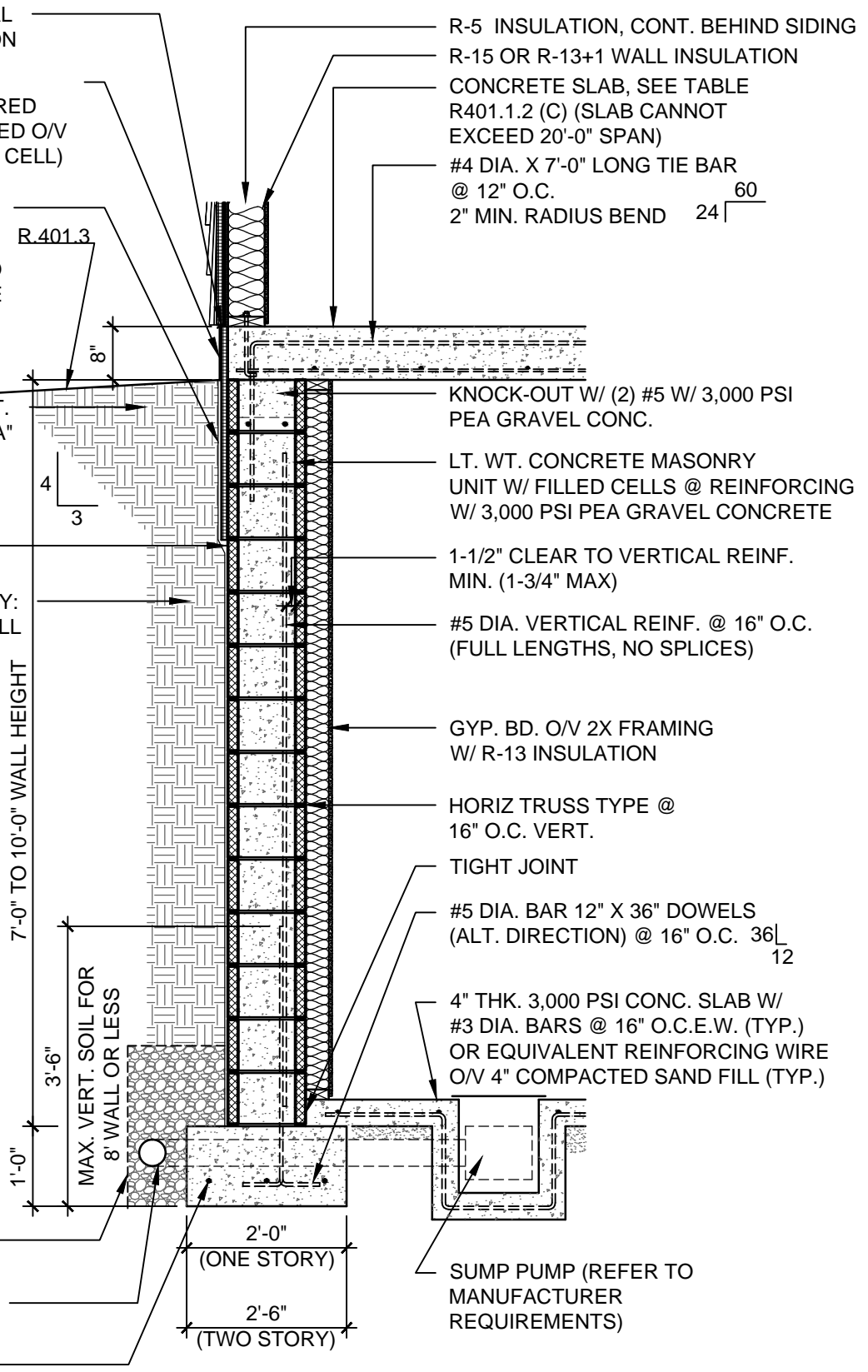

12" CMU BASEMENT PERIMETER WALL DETAIL W/ SIDING

SCALE: 1/2" = 1'-0"

22 GA. PRE-FINISHED METAL OR STUCCO O/V INSULATION
 R-5 INSULATION, CONT. @ PERIMETER W/ SELF ADHERED WATERPROOFING EXTENDED O/V ENTIRE SURFACE (CLOSED CELL)

CONCRETE SLAB, SEE TABLE R401.1.2 (C) (SLAB CANNOT EXCEED 20'-0" SPAN)
 #5 DIA. X 6'-0" LONG TIE BAR @ 16" O.C.
 2" MIN. RADIUS BEND $\frac{60}{24}$

DRAINAGE BOARD SYSTEM
 FINISH GRADE (8" MIN. DISTANCE FROM EARTH TO SILL PLATE) (SLOPE GRADE @ 1/2" : FT FOR 5'-0" MIN. AWAY FROM FOUNDATION)



SLOPE 3' HORIZ. TO 4' VERT. FOR UNDISTURBED TYPE "A" SOILS ONLY AS PER CFR TRENCH SAFETY CRITERIA

FOUNDATION DAMPPROOFING WALL CONSTRUCTION ONLY: ASTM-D698 COMPACTED FILL TO 90% STD. PROCTOR W/ +/- 3 MOISTURE CONTENT

NOTE:
 NO BACKFILLING UNTIL TOP SLAB IS IN PLACE (TYP.)

7'-0" TO 10'-0" WALL HEIGHT

MAX. VERT. SOIL FOR 8" WALL OR LESS

KNOCK-OUT W/ (2) #5 W/ 3,000 PSI PEA GRAVEL CONC.
 LT. WT. CONCRETE MASONRY UNIT W/ FILLED CELLS @ REINFORCIN W/ 3,000 PSI PEA GRAVEL CONCRETE
 1-1/2" CLEAR TO VERTICAL REINF. MIN. (1-3/4" MAX)
 #5 DIA. VERTICAL REINF. @ 16" O.C. (FULL LENGTHS, NO SPLICES)

GYP. BD. O/V 2X FRAMING W/ R-13 INSULATION
 HORIZ TRUSS TYPE @ 16" O.C. VERT.

#5 DIA. BAR 12" X 36" DOWELS (ALT. DIRECTION) @ 16" O.C. $\frac{36}{12}$

4" THK. 3,000 PSI CONC. SLAB W/ #3 DIA. BARS @ 16" O.C.E.W. (TYP.) OR EQUIVALENT REINFORCING WIRE O/V 4" COMPACTED SAND FILL (TYP.)

FILTER FABRIC @ TOP & SIDE OF GRAVEL
 4" PERFORATED PVC PIPE W/ WELL GRADED GRAVEL
 (3) #5 DIA. BARS

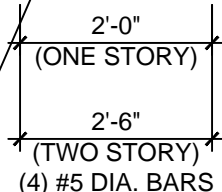

SUMP PUMP (REFER TO MANUFACTURER REQUIREMENTS)

12" CMU BASEMENT PERIMETER WALL DETAIL W/ BRICK
 SCALE: 1/2" = 1'-0"

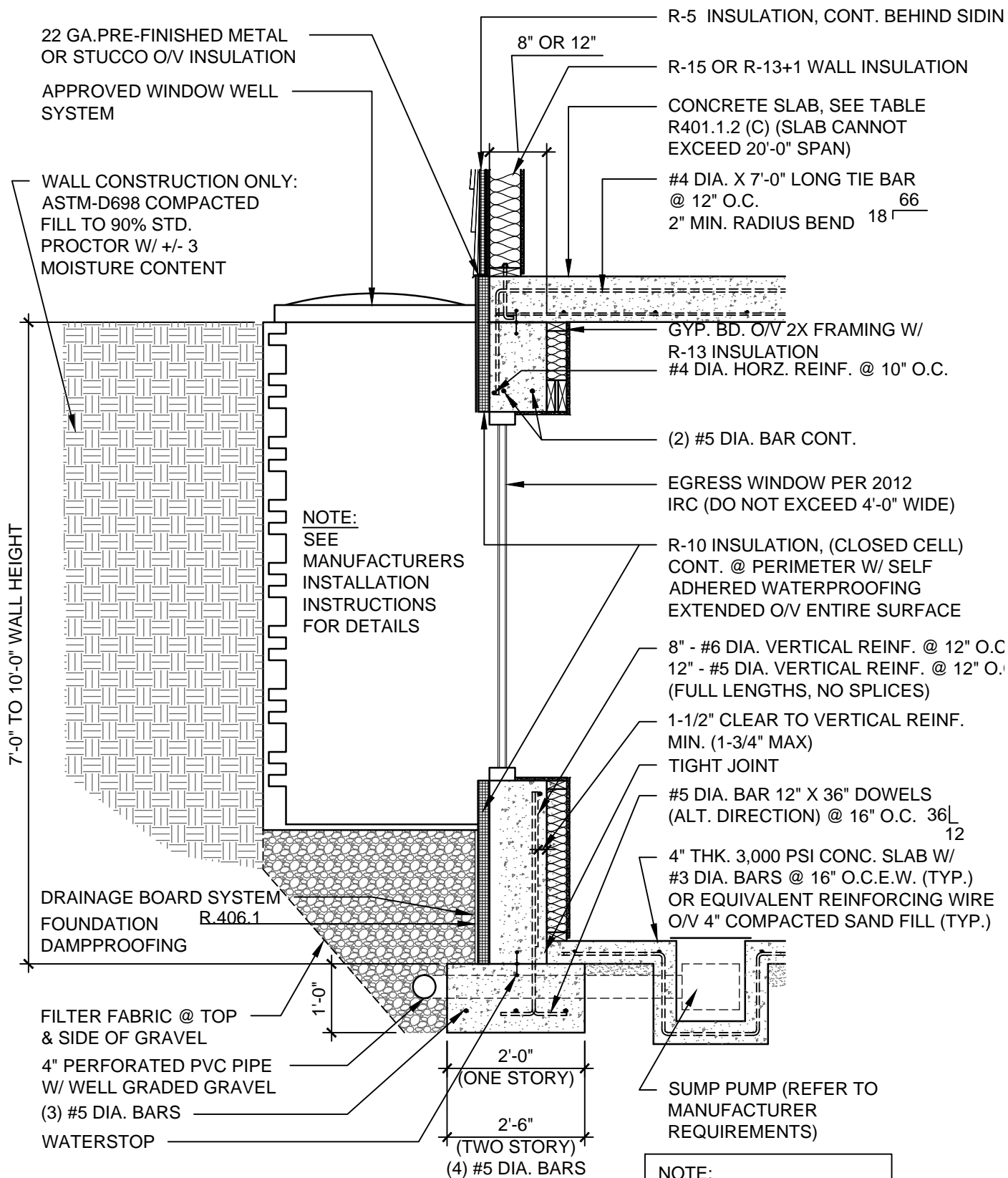

8" OR 12" FORMED BASEMENT PERIMETER WALL W/ WINDOW DETAIL

SCALE: 1/2" = 1'-0"

NOTE:
SEE REINFORCING WALL INTERSECTION DETAILS ON PAGE 11

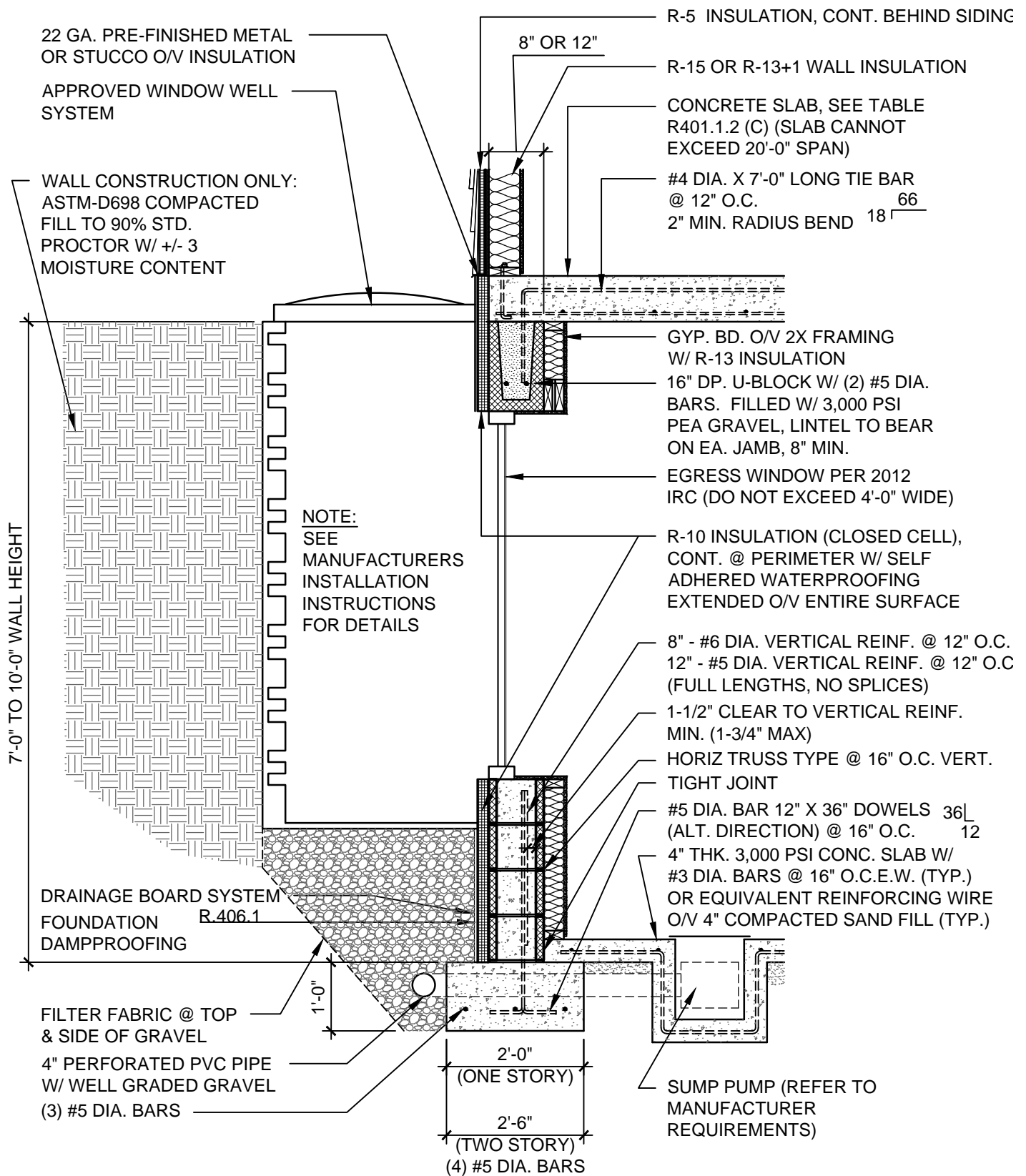

**8" OR 12" CMU BASEMENT PERIMETER WALL
W/ WINDOW DETAIL**

SCALE: 1/2" = 1'-0"

R-13 WALL INSULATION

1/2" DIA. ANCHOR BOLT OR EQUAL @ 6'-0" O.C. MAX. (EMBEDDED INTO FOUNDATION 7") R403.1.6

REFER TO TABLE R401.2 (a) OR (b) FOR THK. 3,000 PSI CONC. SLAB W/ #3 DIA. BARS @ 16" O.C.E.W. (TYP.) OR EQUIVALENT REINFORCING WIRE

#4 DIA. X 4'-0" LONG TIE BAR @ 32" O.C. 2" MIN. RADIUS BEND $\frac{24}{24}$

REBAR LOCATION @ TOP 1/2 OR UPPER 1/3 OF SLAB R506.2.4

R-5 INSULATION CONT. BEHIND SIDING

ENERGY NOTE:
IF ACCESSORY BUILDING IS NOT A CONDITIONED SPACE THE R-10 CONT. INSULATION @ PERIMETER GRADE BEAM MAY BE OMITTED.

R-5 INSULATION, CONT. @ PERIMETER W/ SELF ADHERED WATERPROOFING EXTENDED O/V ENTIRE SURFACE (CLOSED CELL)
22GA. PRE-FINISHED METAL OR STUCCO O/V INSULATION

4" COMPACTED SAND FILL (TYP.)

R401.3 FINISH GRADE (8" MIN. DISTANCE FROM EARTH TO SILL PLATE) (SLOPE GRADE @ 1/2" : FT FOR 5'-0" MIN. AWAY FROM FOUNDATION)

PLASTIC CHAIRS (CLIP TO STL. REINF.) OR EQUIVALENT (NON-CORROSIVE)

3,000 PSI CONC. GRADE BEAM W/ STL. REINFORCING CONT. @ TOP & BTM. AS PER TABLE W/ #3 DIA. VERT. TIES @ 36" O.C.

3" CLR. 3" CLR. 3" CLR. 3" CLR.

REFER TO TABLE FOR GRADE BEAM DEPTH R401.2(a) or (b)

INSULATED ACCESSORY BUILDING, MONOLITHIC

SEE TABLE R401.2 (a) OR (b)

SCALE: 1" = 1'-0"

NOTE:
THIS FOUNDATION DETAIL IS APPROVED FOR USE WITH DETACHED ONE-STORY GROUP U WOOD FRAME BUILDINGS LESS THAN SIX HUNDRED (600) SQUARE FEET IN GROSS FLOOR AREA, AND LOCATED ON THE SAME SITE WITH A GROUP R-3 OCCUPANCY

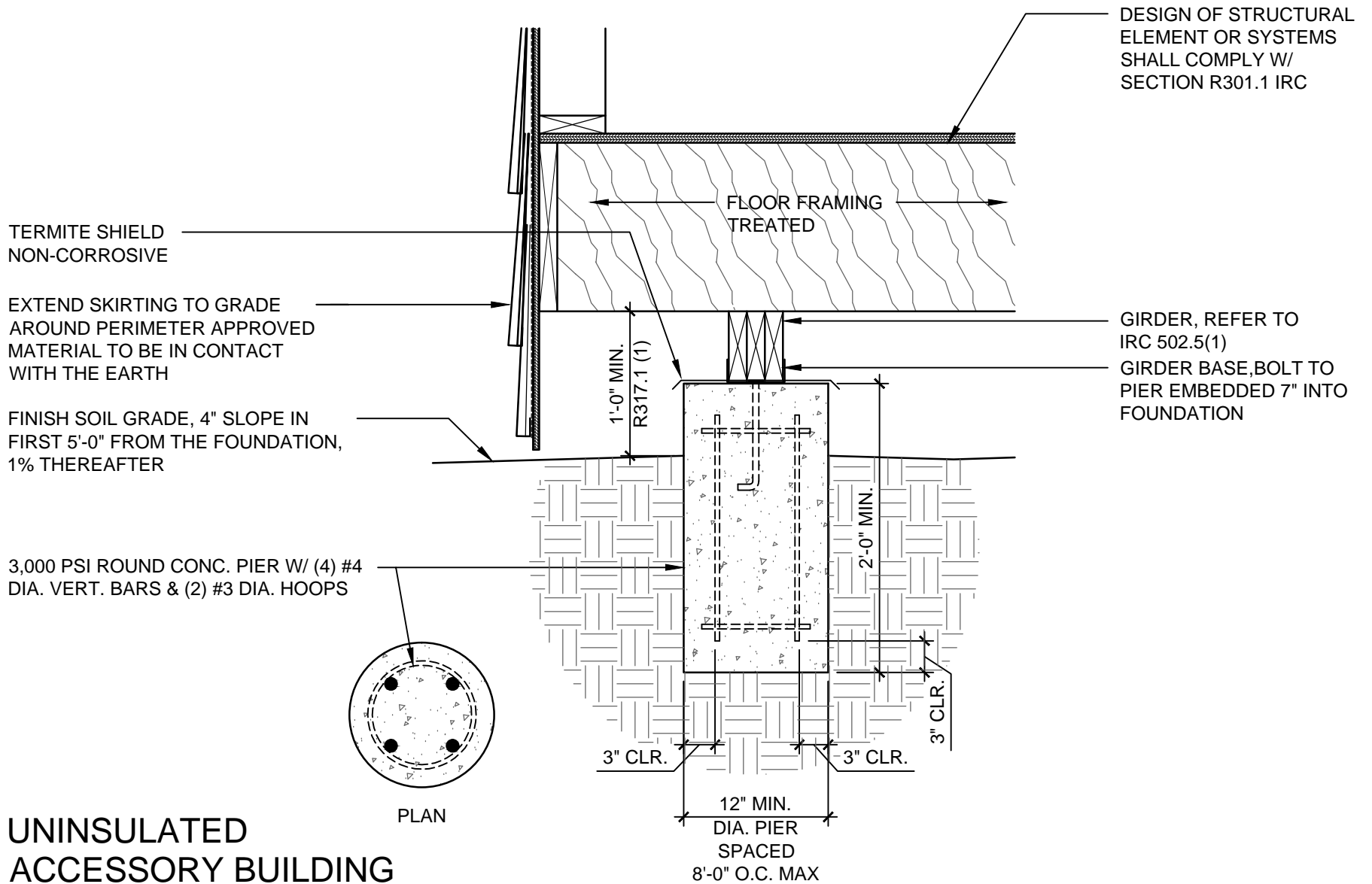

UNINSULATED ACCESSORY BUILDING TREATED FLOOR SYSTEM

SCALE: 1" = 1'-0"

DESIGN OF STRUCTURAL ELEMENT OR SYSTEMS SHALL COMPLY W/ SECTION R301.1 IRC

FLOOR FRAMING NON-TREATED

TERMITE SHIELD NON-CORROSIVE

EXTEND SKIRTING TO GRADE AROUND PERIMETER APPROVED MATERIAL TO BE IN CONTACT WITH THE EARTH

GIRDER, REFER TO IRC 502.5(1)
GIRDER BASE, BOLT TO PIER EMBEDDED 7" INTO FOUNDATION

FINISH SOIL GRADE, 4" SLOPE IN FIRST 5'-0" FROM THE FOUNDATION, 1% THEREAFTER

3,000 PSI ROUND CONC. PIER W/ (4) #4 DIA. VERT. BARS & (2) #3 DIA. HOOPS

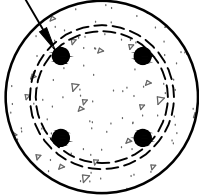

PLAN

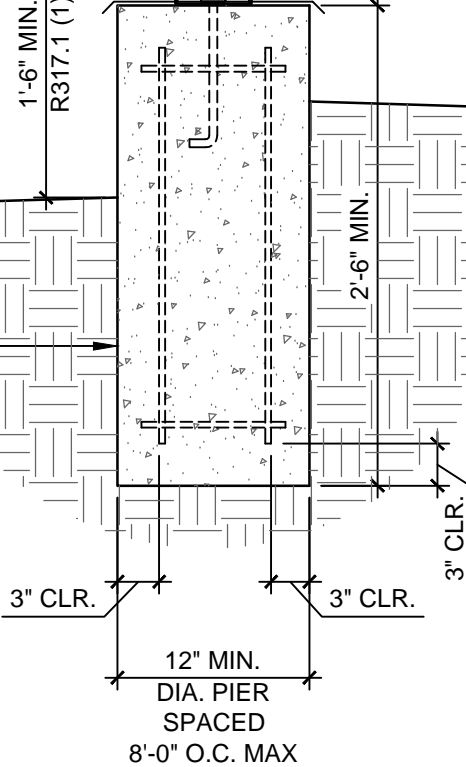

UNINSULATED ACCESSORY BUILDING NON-TREATED FLOOR SYSTEM

SCALE: 1" = 1'-0"

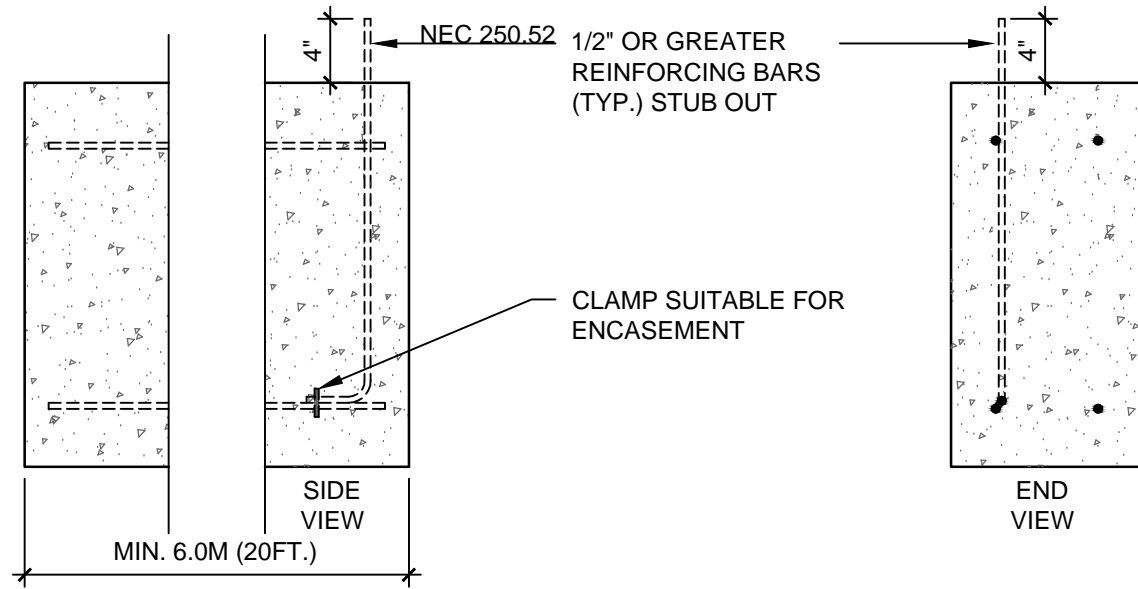

GROUNDING DETAIL

1" = 1'-0"

SECTION 4 – Tools and Resources

The following pages contain a collection of useful tools and resources to aid in proper foundation design.

Methodology for Determining the “Effective PI”

By Ray Tillery P.E.

The following is the methodology for determining the “Effective PI” of any site; as taken from the WRI “Design of Slab on Ground Foundations” of August 1981 (TF700-R-03), page 5.

The WRI reference uses an example to explain the method. The following method is in my own words and my own example to help explain the method. I try to go into a little more detail than provided by the WRI to hopefully add some clarity:

Each layer (D for depth) of soil is assigned a “weighted factor” (F).

For soil layers from the surface to the 5 foot depth, the F = 3.

For soil layers from the 5 foot to 10 foot depth, the F = 2.

For soil layers at the 10 foot to 15 foot depth, the F=1.

The “Effective PI” is computed by the multiplication of the each soil layer depth (D) times its weighted factor (F) times the respective soil layer’s plasticity index (PI); or $D \times F \times PI$.

Then this term for each soil layer is summed for the total depth of 15 feet. This sum is then divided by the sum of the weighted factors for each depth times the respective depth. The following example illustrates this process by use of a table:

Soil Layer Depth (D)	Weighted Factor (F)	F x D	Soil Layer PI (PI)	F x D x PI
0'-2' (2' thick layer)	3	6	25	150
2'-5' (3' thick layer)	3	9	18	162
5'-8' (3' thick layer)	2	6	17	102
8'-10' (2' thick layer)	2	4	16	64
10'-15' (5' thick layer)	1	5	16	80
Sum		30		558
<i>Effective PI</i> = (Sum of F x D x PI)/(Sum of F x D) = 558/30 = 18.6				
<i>Effective PI for this site is 18.6</i>				

FOUNDATIONS FOR A BETTER FUTURE

A Guide to Understanding Foundations and their Design

by Bernard Ray Tillery, P.E. Amarillo Testing & Engineering, Inc.
2911 Amarillo Blvd. West
Amarillo, Texas 79106
Ph# (806) 374-2756
Fax# (806) 374-3277

Copyright© Bernard Ray Tillery 1996

*Republished December 2012 – Panhandle Residential Foundation Manual Appendix
City of Amarillo Department of Building Safety*

Table of Contents

FOUNDATIONS FOR A BETTER FUTURE	1
Get it Right, Right from the Start	1
Types of Structures/Types of Foundation Systems	1
PART 1: EVALUATION SITE CONDITIONS	2
The Unified Soils Classification System	2
Sieve Analysis	2
Atterburg Limits	3
Plastic Limit!!	3
Liquid Limit!!	3
Plasticity Index!!	3
Sandy, Non-Plastic!!	3
Using the System	3
But How Hard is the Soil??	4
Speaking the Language!	5
Constructability of Various Soil Types	5
Rocky Soil Sites	5
Sandy Soil Sites	5
Clayey Soil Sites	5
Fat Clay Sites	6
Fat Clays that are Stiff and Dry in a Natural State	6
Fat Clays that are Soft and Wet in a Natural State	7
Fat Clays at Optimal Moisture Content and Compaction	7
Lean Clay Sites	7
SITE SOILS INVESTIGATIONS	8
Site Visit	8
Subsurface Soils Explorations	8
Formal Soils Subsurface Investigation	9
PART II: SITE PREPARATION	10
Embankment Construction	10
Moisture-Density Relations of Soils	10
Definition of Soil Density	10
Effect of Water in Soil	10
Finding Maximum Density at Optimum Moisture Content	11
Different Density/Moisture Contents for Different Type Soils	11
Different Soils Require Different Treatment	11
In-Place Density/Moisture Content of Soil on the Jobsite	11
Moisture-Density Relations of Soils	12
Standard/Modified Moisture Density Relations of Soils	12
A Unique Moisture-Density Relations for Each Soil	12
JOB SITE PREPARATION	13
Preparations of Level Sites of Clayey Soils	13
Preparations of Non-Level or Sites Requiring Embankment Fill	13
Comments on Types of Soil Used for Embankment Construction	13
Rocks and Gravels	13
Sands	13
Lean Clays	13
Fat Clays	13
Structural Backfill Construction	14
Drainage Considerations	14
Using Embankment Fills to Improve Site Conditions	14
FOUNDATIONS/FOUNDATION DESIGN	15
Foundation Systems	15
Perimeter Grade Beam/Slab-on-grade	15
Residential Pier-and-beam	15
Shallow Spread Footings with Slab-on-grade	16
General Comments Regarding Slabs-on-grade	16
Multi-Story Spread Footings	16
Drilled Pier Foundations	16

Driven Piling Foundations	17
Mat Foundations	17
Raft Foundations	17
Combined foundation Systems.....	18
Specialty Foundations.....	18
Hollow Auger Pier Systems	18
Helical Piers.....	18
Hydraulic Pipe Piers	18
Pressure Grouting	18
Designed Site Drainage.....	18
INSPECTION AND TESTING OF FOUNDATION STRUCTURE CONSTRUCTION.....	19
“Quality in Construction – A Penny’s Effort for a Pound’s Value”	19
CONCLUSION	19

FOUNDATIONS FOR A BETTER FUTURE

The Great Sage once said, "Let your heart soar to the stars, but keep your feet on the ground."

I say, "Build your building as fancy as you please, but start with a firm foundation." While my saying probably doesn't compare quite so well or is as lofty as the Great Sage, but to do other than building with a firm foundation could lead you to profound misery and poverty.

If you were a "Dallas" night time TV soap opera fan such as I was, you will surely remember the downfall of the poor-boy son of ole Jock Ewing, Ray Krebbs. He was a would-be big-time wheeler-dealer, and tried to make it big in residential developments in order to be like his more prosperous half brother, J.R. But he failed when his sites were found to have poor soils which required expensive footings. Poor ole Ray had to go back to being the old ranch hand he started out as and where he decided he should have never left anyway -just because of poor soils and expensive foundations.

Now poor Ray Krebbs was just a make-believe T.V. big-time loser. We are real people with real dreams using real time and money. It was fine for ole Ray to go bust, because he never had nuthin' anyway; but that's a scenario we would like to avoid in our real-world lives.

Unfortunately, I have many opportunities to watch situations such as ole Ray's, occur in my practice of soils and foundation engineering. I have often been called out to evaluate problems with structures and foundations after the damage has been done, and the money is about to be spent.

I often see excessive dollars spent on site preparations and foundations that provide marginal results. I also see insufficient dollars spent and minimal attention given on site preparations and foundation placements, which will eventually cause additional costs and unnecessary grief.

This booklet has been prepared to provide some background for any one who finds themselves involved in any kind of construction project, be they an owner, builder, sub-contractor, or anyone interested or involved in the construction process of the foundation and all features related to the foundation.

Get it Right, Right from the Start!

The key to successful investments in structural foundation systems are the preparation of the foundation plan.

In this booklet, we shall discuss the initial site evaluation. The site conditions must first be considered. Soil types, geology, and circumstances involving water and drainage are all factors that will effect the outcome of the suitability of the foundation system and the eventual successful outcome of the structural system. Resources available on the site should be used economically and harmoniously with the structure.

The foundation should be designed to be efficiently compatible with the on-site conditions and with local convention if at all possible. The designer should have a thorough understanding of the soil-to-foundation interaction. Potential site soil or geology problems should be understood and dealt with. The site should be properly prepared for the foundation structure prior to any placements. Proper site drainage should be assured. This booklet will delve into specific details regarding this process.

Types of Structures/Types of Foundation Systems

The type of structure, whether it be residential, commercial, or industrial/specialty will play a major role in the foundation configuration. The type of site and geology shall dictate largely the foundation system, as will the prior site preparation or site improvement circumstances. A foundation system may be very standard, or it may be very unique. The suitability to the use of the structure and the site adaptability shall dictate the type of foundation system to be used. This booklet shall discuss the matching of foundation types to the site and their use in relative detail.

PART 1: EVALUATING SITE CONDITIONS

The first step to any anticipated construction project is site selection. A preliminary site evaluation is essential even prior to site selection. Just ask poor ole Ray Krebbs about site selection. It may often be far advantageous to select another site if poor soils on the proposed site could add significantly to the cost of the foundation, and thus the entire structure.

Of course, some knowledge of geology and site soil condition evaluation would be prerequisite in any preliminary site evaluation. Common local knowledge is often helpful. However, common local knowledge doesn't always reveal a site-specific problem. No one should ever seriously contemplate a site until some type of understanding of site conditions are ascertained.

This part of the booklet shall discuss site conditions, geology, and basic soil engineering principals that can be used by anyone with a rudimentary understanding of the basics.

The Unified Soils Classification System

Most engineers who deal with soils in construction utilize a methodology of the classification of soils known as the Unified Soils Classification System. This method of soil classification is based on a few simple physical characteristics of soils combined with a universally understood "language" of soils engineering. By being conversant in the "language" of soils engineering, anyone can visualize the circumstances of the site by the study of a soil report, by simple laboratory tests, and by other persons involved in the business of site preparations and evaluations.

The Unified Soils Classification System (USCS) divides all soils on the surface of the earth into four separate categories as follows:

<u>Soil Type</u>	<u>USCS Symbol</u>
Rock/Gravels	G
Sands	S
Clays	C
Silts	M

Simple enough, wouldn't you say? It gets a little more complex, but not much.

A method of quantifying what classifies each of these soil types stands to follow. Two primary tests or physical characteristics help make this happen. These physical characteristics are known as the "sieve analysis" and the soil's "Atterburg Limits".

The sieve analysis is easy enough to explain and conceptualize. A sieve analysis of a soil is simple just as it says. The soil is passed through different sizes of sieves, or screens, to determine the amount of soil that fits certain sizes of particles in any given soil. The Unified Soils Classification System provides thresholds for each soil type to given sizes as follows:

Sieve Analysis

<u>Soil Class (USCS Symbol)</u>	<u>Size of Soil Particles</u>
Rock/Gravel (G)	3" to #4 Sieve (About 1/4")
Sand (S)	#4 Sieve (About 1/4") to Q200 Sieve (.075 millimeter or nearly microscopic)
Clay (C)	Smaller than #200 Sieve (Microscopic) and Plastic
Silt (M)	Smaller than #200 Sieve (Microscopic) and Non-Plastic

Coarse Grained Soils - Greater than 50% Retained on the #200 Sieve

Fine Grained Soils - Less than 50% Retained on #200 Sieve

In the above classification, I introduced the term "Plastic" without explanation. I did say it would get a little more complicated,

and this is it. However, a simple explanation should help clarify the matter. This is where I introduce the concept of "Atterburg Limits".

Atterburg Limits

Atterburg limits are terms that measure a soil's state under different conditions of moisture content. Three terms are used to describe the "Atterburg Limits" of a soil. These terms are "liquid limit (LL)", "plastic limit (PL)", and "plasticity index (PI)".

In order to visualize the concepts of liquid limit and plastic limit, we first must visualize a lump of soil. Let's say that this lump of soil is initially very dry. Think of this lump of soil as a "clod" of soil. Everyone knows that a clod of soil behaves as a solid and is not often easy to break apart. Let's assume for the moment that this clod is a lump of clay-type soil.

Plastic Limit!!

Now bring this clod of soil into the kitchen and place it on a plate. Add small amounts of water to the clod, and begin to knead on the clod as if it were bread dough. Keep adding water to the clod until it behaves as child's molding clay. Once the soil lump behaves more as molding clay than as a solid lump, it is now considered to be plastic. Now take a sample of this soil, weigh it, then put it in the oven and dry it. After it's dry, weigh it again. The difference in the weight is the amount of water that was in the soil before it was dried. Divide the weight of this water by the weight of the dry soil, *and you have the soil's moisture content where it goes from a "solid state" to a "plastic state"*. The lump of soil is at its "plastic limit (PL)" at this time, and it is defined by its moisture content at this point. Let's say that the moisture content of our soil sample was found to be 20%; or the PL = 20.

Liquid Limit!!

Keep adding more water to this lump of soil that is now in a "plastic" state. If you keep adding water, the soil starts to become what we would often describe as "mud". As water is added to the soil, it behaves like mud, which means it is becoming more liquid than plastic. Everyone knows how easy it is to get stuck in a muddy road. The soil has no strength, and it mashes under the tire load. At a certain point, this soil is no longer plastic, but it now comes to behave more as a liquid. The soil now can be said to have attained its "liquid limit". *As with the plastic limit, the liquid limit of a soil is defined by the soil's moisture content at the time it is determined to go from a plastic state to a liquid state.* Again, a sample of the soil is weighed, then dried in the oven. The moisture content is computed as noted above. Let's say our sample had a moisture content of 45% at the point where the soil goes from a plastic state to a liquid state. This is the definition of the soil's "liquid limit (LL)". The liquid limit of this soil (LL) = 45.

Plasticity Index!!

We now have two terms, the soil's plastic limit and the soil's liquid limit. The term "plasticity index" is yet to be defined. The "plasticity index" of the soil is simply an arbitrary term that relates the values of the soil's liquid limit and plastic limit.

The soil's "plasticity index" is defined as the numeric difference between the liquid limit and the plastic limit of a soil, or:

Liquid Limit (LL) - Plastic Limit (PL) = Plasticity Index (PI)

In our sample, the LL = 45, and the PL = 20. This means that the

$$PI = LL - PL = 45 - 20 = 25.$$

The soil sample we have just examined has a "PI" of 25.

Sandy, Non-Plastic!!

Now let's consider a soil that we would commonly describe as a sand. Visualize placing a sample of the sand on a plate and add water in the same manner as you had done to the clay lump above. In the first place, the sand soil sample probably won't remain in a lump when it is picked up. It will probably break up. When you start wetting the sand sample, you will note that it won't start behaving as molding clay. It will essentially behave as it did before it became wet. It will not change until it becomes so wet that it is immersed in water, but its basic nature never changes. To say the sand sample has a plastic state and a liquid state is not accurate. It simply does not behave in the same manner as a clay. You would then say that the sand sample is "sandy, non-plastic". The sand has no plasticity, therefore, it is described as "sandy, non-plastic" or SNP.

This is the primary difference between sands (and non-plastic silts) and clays. Sands and silts are non-plastic, while clays are plastic.

Using the System

We are told a lot about a soil when we know its "PI". Knowing a soil's "PI" gives us an idea of how that soil will behave under various conditions and how it will respond as a soil base material for construction.

Before we get into all that, though, let's finish our descriptions of the soil as determined by the Unified Soils Classification System as to how the concept of Atterburg limits are used.

As is noted above in the quantitative definitions of soils under the Unified Soils Classification System, a clay-type soil (C) is termed to be "plastic".

This means that a clay soil has a certain "plasticity index", or PI value, to be described as a clay. Conversely, a sand-type soil (S) and silt-type soil (M) are described as "non-plastic".

We now have a concept and a methodology for providing for the physical descriptions of soils, and this is all that is essentially necessary for determining the basic nature of any soil. Now of course, hardly any soil exists that is just sand, or just rock, or just clay.

Most soils in nature have combinations of the different type soils. The Unified Soils Classification System takes these variabilities into account by further breaking down the definitions of the soils as follows:

COARSE GRAINED SOILS (50% or more of the soil's particles are larger than the #200 sieve, or larger than microscopic):

<u>Soil Description</u>	<u>uscs Symbol</u>
Well Graded Gravel	GW
Poor Graded Gravel	GP
Clayey Gravel	GC
Silty Gravel	GM
Well Graded Sand	SW
Poor Graded Sand	SP
Clayey Sand	SC
Silty Sand	SM

¹Note that these soils are defined as "non-cohesive", or they do not stick or bond strongly together when wetted. It should also be noted that non-cohesive soils are typically permeable in nature. This means that water flows readily through non-cohesive soils.

FINE GRAINED SOILS ² (50% or more of the soil's particles are smaller than the #200 sieve, or microscopic or smaller):

<u>Soil Description</u>	<u>USCS Symbol</u>
<i>Liquid Limit (LL) is 50 or less:</i>	
Lean Clay (Moderately Plastic)	CL
Silt (Non-Plastic)	ML
Organic Clay (Low to Moderately Plastic)	OL
<i>Liquid Limit (LL) is 50 or more:</i>	
Fat Clay (High Plasticity)	CH
Fat Organic Clay (Highly Plastic Organic Clay)	OH

²Note that the plastic soils in these categories are considered "cohesive", or that they bond rather strongly when wetted to a certain degree by internal soil "cohesion". It is also noted that cohesive soils are typically "impermeable", which means that water does not readily flow through cohesive soil strata.

But How Hard is the Soil??

In subsequent discussions, we shall denote clay soils for their relative supporting strength. Generally, clays can be stiff, or hard, or on the other hand they can be soft. Of course, clays can be anything in between hard and soft. A hard clay is essentially a clay that is in its solid state, or the soil's moisture content is less than the soil's plastic limit. A soil that is moderately firm, but not hard is probably in its plastic state. The soft soils are approaching the clay's liquid state.

This means that an idea as to how hard or soft a clay soil can be can be had by examining the soil's moisture content, then compare that moisture content with the soil's plastic and liquid limits. For example, say a clay soil has a plastic limit of 18. The moisture content of that clay as shown in the soils report boring logs is 15%. This means that this particular clay layer exists in its natural state at 15%, which is less than the soil's plastic limit of 18%. This would indicate that this soil is in a solid state, and therefore stiff to hard.

The Unified Soils Classification System further breaks down the soil types, but the above are the basic soil types that may be of interest to anyone but the soils engineer.

Speaking the Language!

This is essentially the language of soil engineering. All soil reports and many job specifications use these symbols or similar notations to describe the type of soils that exist on a site or the type of soils that are to be used for construction. It is now important to relate the soil type to its applicability to the construction site.

Constructability of Various Soil Types

Now that we have a basic understanding of the normally encountered soil types and how they are defined, we can go on to describe the different soils and how they relate to the construction project, the site development, and the foundation design. We can glean valuable insight with regard to the suitability of a site for our particular project by observing a few details about the soil characteristics of a site, and we shall examine these characteristics as to how they apply to our site.

Local history and common knowledge among building professionals is very useful with regard to site evaluations. Past experience on a similar site is very useful information and should not be ignored. However, the prospective builder should keep in mind that site conditions can change unexpectedly. It is also common that existing methods can be greatly improved upon by a few simple knowledge factors that may have not been commonly practiced in the past. In any case, an open mind without accepting generally accepted assumptions with regard to local experience should be kept at the inception of every project.

Rocky Soil Sites

As the Bible says in Matthew 7:24-25, "All who listen to my instructions and follow them are wise, like a man who builds his house on solid rock. Though the rain comes in torrents, and the floods rise and the storm winds beat against his house, it won't collapse, for it is built on rock." While we know Jesus was using this story as a spiritual analogy, rather than as technical building advice, this is more or less true in the world of foundation design.

The geology of any site that is composed primarily of rock must be understood before any plans are drawn. Rock strata is normally layered in planes if the rock originated as sedimentary type rock. If the planes are horizontal as they often are in the flat land type country, then a rock site can be very stable from a geologic standpoint. However, if the rock layers are inclined as they often are in mountains or areas that have been geologically active, then a rock site can be unstable and even hazardous if the site is tampered with or otherwise has its conditions changed.

A good example would be a site that is located on the side of a hill which is underlain by slanting layers of rock strata. Should one excavate out a level area in this hill, the inclined layers that were supported by the since removed layers down the hill are no longer supported. It is conceivable that the planes between the rock layers could become wetted, thus lubricating the inclined layer. Any large wet storm may grease the layers and cause an entire layer to slide down on the excavated area where a house may exist. This could bury the house and doom the residents!

It has happened before, and it will probably happen again. If you understand the geology of the situation, it won't happen to you.

So if you build your house on rock, you may or may not be safe. A few other factors need to be considered on a rocky site. Who is going to dig the holes for the foundation, and who is going to trench the plumbing lines? Obviously, building directly on the rock can

contribute substantially to the cost of construction. Say that you want to build a basement, and you plan to build on a nice flat site where the grass grows. Let's say you've looked over the site, but you don't really know the substrata soil conditions. You hire your contractor, and he proceeds to dig your basement with his backhoe. Three feet down, he encounters a solid rock layer. You must now decide whether to continue the basement plans at a much higher cost, or scratch the plans for a basement. A rocky site has definitely affected your plans. It would have been nice to have known this from the beginning.

The bottom line is that a rocky site adds considerably to the cost of foundation construction, and the hazards of building on a rock site could be insidious. Often people deal with a rock site by simply building above it with a workable soil layer for a pad.

Sandy Soil Sites

Matthew 7:26-27 says, "But those who hear my instructions and ignore them are foolish, like a man who builds his house on sand. For when the rains and floods come, and storm winds beat against his house, it will fall with a mighty crash." Well, in some cases the above can certainly happen, but a whole lot more is involved.

Again the geology of an area is important to understand regarding a site. A sandy site can be a very desirable site for construction if the sands are very dense in their natural state. However, a loose sandy site can be a very problematic situation. The geologic history has significant bearing on this. If the sandy site exists because of either being wind-deposited or water-deposited, the sandy soil strata will be very loose and subject to significant settlement under heavy or vibrating loadings.

Good examples of wind-deposited sandy sites are sites where sand dunes predominate. The sandy prairies that roll gently are all wind-deposited sandy sites. It is probable that these sands are very loose and susceptible to settlement. Another area of loose sands would be against the foothills of mountains where alluvial sands or water-deposited sands would exist against the mountainside. This same circumstance would exist for sandy sites in or near the bottom of a water course. These sands will most often be very loose.

On the other hand, sands that have been covered for aeons by layer upon layer of more recent soils which have subsequently eroded away are often very dense in their natural state, and are very stable, and not likely to settle. These sands are often cementations since they were under high loading pressure along with cycles of moisture, and have a certain body to them. These sandy sites are often excellent for construction purposes. A good example of sands that are dense from historic overburden are the Ogallala sands found in the Ogallala geologic formation. These sands were laid when an area was under the sea, and subsequent layers of limestone and clays had been placed over these sands over great periods of geologic time, thus densifying these sands. Subsequent erosion revealed these soil strata at the surface where we may now be contemplating to build.

As previously noted, sandy soils are of low plasticity, or are non-plastic.

This means that such sandy soils are not subject to structural change when wetted as clays would be, as we shall soon describe.

Sands are considered "permeable". This means that water readily flows through sand. This can be good when the subsurface site drainage is good, but it can be a problem if the sandy site has a shallow water table level, and a basement that extends into the water zone is planned. It can also be a problem if the construction results in a subsurface zone of water accumulation in the sand strata.

Generally speaking, sandy soils are desirable building materials when properly handled and used because of their non-plastic characteristics. A properly prepared site using sandy soils is often an excellent site for construction. Sands do have some disadvantages: they are non-cohesive, and trenches for foundations and plumbing can slough. Unprotected sand slopes can be highly erodible. Confined sands in a clayey environment can act as an undesirable subsurface "reservoir" for confined moisture.

The bottom line is that all advantages and disadvantages of the sandy site and its use must be understood in the design of the site and the foundation system.

Clayey Soil Sites

Clayey sites can be very good, but clayey sites can be very bad. So how's that for a good generalization regarding clayey sites! We are not given any biblical guidance with regard to building a house on clay; I guess that's the reason it's so wishy washy!

Again, if I haven't said it enough, it depends on the geologic history of a site, and the specific site configuration, and on (now this is an added feature) the type of clay that composes the site. When I say type of clay, I am referring to the degree of plasticity of the clay, but I am also referring to the moisture conditions of the clayey site, and to the firmness, or stiffness of the clayey site. The problem with plasticity of clays is that the more highly plastic the clay is, the more reactive that clay is to the presence of and changes in the moisture content of the soil.

Remember from the above discussions of the plasticity index of a soil that the physical nature, the physical state, of a clay will change with the changes in the soil's moisture content.

This is why the concept of plasticity is so important in soils, and this is where the knowledge of the concept of soil plasticity can literally make or break the integrity of a particular construction project!

Fat Clay Sites

Generally, sites that consist of fat clays, or clays with a high plasticity (Liquid Limit is 50 or greater), are problematic sites. The following are various site circumstances and the ramifications of those circumstances:

Fat Clays that are Stiff and Dry in Natural State

This circumstance is very common in arid and semi-arid regions. The fat clays have assumed a natural dry state, and over the aeons they have contracted to a very hard and solid condition with little in-situ moisture. These soils provide excellent strength and bearing capacity as long as they are not disturbed by the intrusion of water. These soils can be considered relatively impermeable as water does not readily pass through a strata of fat clays.

Exposure to water changes the situation. Unfortunately, it is common that new construction on a site of dry and stiff fat clays will often change conditions regarding the exposure to water once the grade is changed and landscaping and artificial irrigation is begun. Long term exposure to moisture will cause fat clays to act as a sponge. As these soils become wetter, they become more plastic, and if sufficiently wetted, they become as liquid. This means that the initial stiffness and natural soil strength is lost as the soils become more moist, and the soil strata is weakened structurally.

The weakening of the soil structure is only part of the problem. As previously noted, fat clays are defined as those clays that have high plastic limits and high liquid limits. This means that these soils go from a solid state to a plastic state when the soil moisture content becomes very high. The same occurs as the soils go from a plastic state to a liquid state. This means that these soils take on a lot of water for any given volume of soil. These soils act like a sponge. They take on tremendous volumes of water, and this results in swelling, or an increase in the volume of an initial volume of soil.

If a house that is lightly loaded happens to rest on these soils that were initially dry but have become wet, then severe problems with uplift by swelling soils will result. As I have previously said, these fat clays are relatively impermeable. This means that it takes a long time for fat clays to swell as they are continuously exposed to moisture. This is why fat clays that are uplifting are so insidious, expensive, and sometimes impossible to completely repair. The soils just keep swelling. Correction of drainage and exposure to moisture can help, but often the long term process is on-going and underway for a long, long time.

As can be imagined, a house with a flexible foundation built on stiff and dry fat clays with poor drainage and lots of landscaping can make even ole Ray Krebbs miserable.

Most of the construction repairs and lost money due to property degradation in this nation, and probably all over the world, are due to problems dealing with swelling (and sometimes shrinking) soils.

Typically, people think their house is settling when the structure is actually being subjected to swelling or uplifting soils. The portions of the house that are exposed to excessive moisture, such as around exterior perimeter of the house, tend to uplift. However, the portions of the house such as those near the center where no moisture changes take place do not change in elevation. This makes the homeowner think the house has settled in the center.

In reality, though, the house has uplifted around the edges. Of course, the more irregular the perimeter and the more rambling the house, the greater are the notable resulting wall, floor, and ceiling cracks. Most horror stories are the result of the above scenario.

Fat Clays that are Soft and Wet in a Natural State

As previously noted, fat clays that are wet and soft are weak. This means that such a soil strata has very little foundation bearing capacity. Heavily loading footings in such soils will result in a slow settling action. This settling is the result of a phenomenon known as "consolidation". Wet and soft fat clays are "compressible". In the process of consolidation, the structurally-loaded clays that are "compressible" are subjected to pressures that cause the water to be literally squeezed out of the soil strata. The opposite mechanism from the swelling of wetted soils now takes place. The moisture is squeezed out of wet, soft clays, and the clays are reduced in volume. This means the clays are shrinking, which can result in settling.

As previously noted, fat clays are relatively impermeable. This means that this consolidation action, or the squeezing of water out of the soils can be a slow process. The soils will slowly compress under constant load until the water pressure (commonly known as pore pressure) reduces down to a stable level.

Another problem regarding shrinkage of soils due to drying by atmospheric conditions can occur. The direction of shrinkage by air drying is different than the problems associated with consolidation. Fat clays that shrink by air drying will appear as one would find at a drying lake bed. In a dry lake bed, the bed soils form large cracks and fissures over the surface. These cracks can extend into the soil strata a few inches, or several feet. Imagine the same situation in the vicinity of a house that had initially wet and soft fat clay soils, but are then forced to dry due to changing conditions. The clays will shrink and crack or fissure just as the lake bed does. This may cause some settlement, but the main problem is in the fact that the cracks and fissures have provided avenues for more moisture should the site ever be re-watered. The result would be an even greater moisture intrusion had the site never been allowed to dry.

This is why it is important that any landscaping on any site be kept as moderate, but consistent. Erratic irrigation can be a major detriment to a structure with any site, but particularly one with fat clays.

One can imagine the result of consolidating soils beneath a structure. Of course, the heavy industrial-type structures are much more subject to damage under these conditions than would lightly-loaded residential structures be. Keep in mind, though, that many residential structures have heavy concentrated loads at fireplaces, etc., and the resulting differential movements can be devastating.

Fat Clays at Optimal Moisture Content and Compaction

So far, all of our discussion regarding construction of fat clays has been one of strife and misery. Truly, fat clay sites have been the nemesis of the construction world, particularly in home construction.

However, even poor sites of fat clays can be dealt with and used successfully. Proper knowledge and treatment are essential elements to successful construction on fat clay sites.

The efforts must be two-pronged the site must be modified and properly prepared, and the foundation system must be designed to accommodate the pressures of both uplifting and compressive soils.

The proper preparation of a site typically will involve processing as much of the soil strata as possible to obtain the soil at an optimal moisture content and compaction.

Later in this booklet I shall discuss site preparation with regard to moisture and compaction. However, let it be assumed at this point that fat clays can be compacted to a maximum reasonable density at a moisture content that renders the soils relatively strong and relatively impermeable by a process of moisture distribution and remolding to a moist, but firm, state.

Under these optimal conditions, the soil will not be as susceptible to additional moisture intrusions, because optimal soil conditions help seal the soil from moisture intrusion. Additionally, the placement of initial beneficial moisture as a part of the soil structure means that the swelling action will be minimized to a reasonable degree. The proper compaction of these soils leads to a stronger, less reactive soil layer.

Lean Clay Sites

All of the conditions noted at fat clay sites also apply to lean clay sites. However, lean clay sites are basically safer and more easily prepared. The swelling and shrinkage potential is lower, and the compressibility is not normally as severe in lean clays as in fat clays.

The same actions and precautions noted for fat clays also apply to lean clays. The difference is that lean clays cut a little more slack with regards to swelling potential due to moisture intrusions. Lean clays that are initially dry can absorb moisture just as fat clays can. However, the difference lies in the fact that the lean clays reach a plastic limit and subsequently the liquid limit at moisture contents that are lower than the fat clays.

The end result is that the lean clays do not swell to the same degree as the fat clays, nor do they become as compressible as the fat clays. Lean clays are more easily processed and compacted when used as embankment till soils or when lean clay sites are to be improved by optimal moisture and compaction conditions.

All in all, properly prepared and designed lean clay soil sites are considered to be the most versatile, inexpensive to build on, and consistently performing sites of all the possible soil types to be built upon. It is imperative that the guidelines noted for fat clay sites be also strictly adhered to for the lean clay soil sites.

SITE SOILS INVESTIGATIONS

We have discussed the nature of soils, and the ramifications of how soils affect the constructability and conditions on a particular site.

Now, we need to discuss how it is determined what type of soils exists on the prospective construction site.

The site investigation can consist of a simple site visit, or it can involve comprehensive subsurface soils exploration measures with extensive laboratory analysis. We shall discuss various levels of soils investigations and will relate those levels to the probable needs of the construction project.

Site Visit

Oftentimes, an observation of the site conditions of the proposed construction project will offer significant information for the knowledgeable observer who is aware of what he is looking for. Combined with past local experience and local convention, a site visit may properly suffice for the site soils investigation. This all depends on his experience of an area, and the consistency of the terrain in the vicinity of the new site compared to his past experience.

An example of such a site would be a residential lot in a development that was well established with other homes on sites of similar terrain to the site under consideration. Care should be taken, though, because oftentimes the residential lot may have been disturbed by either excavations or by embankment construction. One must be assured that any embankment work had been properly controlled by a good set of specifications during the construction process.

If the site has been processed in some manner, it can be expected that naked soil without well-rooted vegetation exists. It can be expected that soil was either moved from or to the site. By using a shovel, the soil down to a depth of one to two feet should be

turned up. The soil should be examined. Does the soil appear to be a fat clay, lean clay, or sand? If shrinkage cracks are noted on the surface that extend down more than a few inches, it can be expected that the soils are fat clays. The overall site drainage should be determined, and assurance of no flood zone should be established. Is the soil loose, powdery, and composed of broken clods? This indicates the recompactive effort was poor or non-existent. Poor compaction of any embankment fill soil will create all those problems noted with sands, fat clays, and lean clays. Obtain a sample of the soil, and try to determine how clayey or sandy that soil is. Take it to a laboratory for analysis. Have in-place soil density (compaction) tests performed in the field, if necessary.

After observing the site-specific conditions, observe any structures that exist in the immediate vicinity. Note the construction and the apparent performance of that construction.

Try to obtain a feel for the general geology of the site. Are rock outcroppings visible at nearby elevation changes? Are there water courses in the immediate vicinity? Do significant terrain features such as canyon walls, mountains, or hills exist in the area? Excavations from other nearby construction projects may be very helpful. Much information can be gleaned from the evidence provided by local features.

Subsurface Soils Explorations

One normally thinks in terms of hiring a soils engineer to perform a subsurface soils analysis. In many cases, this would be the next step. However, the cost of a formal soil engineer's exploration can seem expensive. When you hire us, we are obligated to give you a professional opinion concerning the conditions of the subsurface soils. That's why I would hesitate just to go look at a site informally for you. You would then take what I said as gospel truth whether I had performed any engineering work on the project or not. If later a problem arose, you would then seek me out. If you are going to seek me out under those circumstances, I would have like to have had sufficient information necessary to make the proper judgement and receive reasonable compensation for my work.

You could, of course, perform your own subsoil investigation if you feel relatively comfortable with identification of soil types and with soil conditions. By hiring a backhoe, you can dig small trenches as deep as ten feet, and you can observe the condition of the soil as the shovel retrieves the soil from the trench. A good backhoe operator can perform three or four of these trenches in an hour. So for less than a hundred bucks and a little of your time, you can perform a pretty fair "do-it-yourself" sub surface soils investigation.

The only problem is that if you miss some significant evidence in your confident manner of soils analysis, or if there is a problem deeper than 10 feet, you could cause yourself more grief than not. If in doubt, always discuss the situation with a soils engineer, and be prepared to pay him for his time and allow him to do the minimal testing he may recommend.

The same goes for the site preparation and foundation design. The soils engineer may offer useful tips for the site preparation and foundation design that may save you a great deal of grief down the road. He may even be the best person to provide the foundation design.

Formal Soils Subsurface Investigation

Several advantages result from a professional soil investigation and exploration program. The soils investigation provides logs of the soil types, moisture contents, soil strengths, water levels, and general comments with regard to the terrain and site geology. The astute soils engineer will almost always want to personally visit the site, so you should be willing to compensate him so he can do so.

The good soil engineering report shall provide alternative recommendations for foundation design types for the particular site. The report should also warn the potential builder of any special problems that the site may present. Recommendations regarding proper site preparation should be offered. Specifications with regard to that site preparation will be provided. Recommended soil strength parameters such as allowable foundation soil bearing capacities, lateral soil strengths, and soil Atterburg limit values with soils classifications should be provided.

Oftentimes, the soils exploration report shall provide useful information that may be needed for a pavement design.

A formal soils subsurface exploration should be conducted any time the site could potentially offer design problems, when the structure is loaded with more than very light loadings, when deeper foundation systems are being contemplated, or any time the comfort zone for the soil conditions of a site is in question.

The subsurface exploration report shall present the soils data on records of subsurface exploration logs. The knowledge you have gained earlier in this booklet regarding the Unified Soils Classification System will help you interpret the soils information on those logs for yourself.

For example, remember from the discussion of in-situ soil moisture contents for clays that showed a soil to exist at a moisture content below the soil's plasticity index. This would indicate that the soil as shown in the logs to be relatively hard, and not soft. Had the soil report shown the soil moisture content to fall between the plastic limit and the liquid limit of the soil, then the soil layer would be expected to be firm to soft.

The soil report shall state specifically as to whether the soils are rocky, sandy, lean clays, fat clays, etc. A foundation design concept shall be presented that shall match the site with the foundation design.

NOTES ON PART I

PART II- SITE PREPARATION

This part of the booklet is devoted primarily to the various aspects of site preparation and the job specifications that provide the guidance for appropriate site preparations.

Exotic site improvement scenarios are offered by specialists such as subsurface soil grouting, improvements of soils by chemical treatments, vibration compaction, etc. These specialty methods can have their place in a project. However, we shall limit our discussion to basic site improvement and site preparation technology that is common and commonly performable by local resources.

The principles of site preparations remain relatively simple in concept, but as with other aspects of soils and foundation engineering, the ramifications regarding site preparations can become relatively complex. We shall attempt to lay out the basics as building blocks so that the more complex problems can be dealt with one step at a time.

As previously noted, the typical site soils investigation and exploration should provide sufficient information with regard to site and job-specific site preparations. However, these recommendations will only be based on the principles to be presented.

Different methods of site preparations are presented. However, most site preparations involve the movement or the processing of soils. This involves both excavation and embankment construction. Principles of proper embankment construction must be examined prior to any discussion of site preparations as follows:

Embankment Construction -

Improper moisture control and poor compaction of any earth moving task is a major contributor to foundation and structural failure. I have found that the problem with appropriate earthwork construction is the lack of understanding of the problems associated with earthwork when it is placed improperly. We shall discuss the basic principles of proper moisture in earthwork and the compaction control of that earthwork. The concepts are relatively simple once one has a basic understanding of how soil responds under varying conditions.

The key to good earthwork construction is proper compaction at a moisture content that fosters the maximum densification, or compaction, of a particular soil. As we discussed earlier, the earth is composed of many types of soils that react to environmental conditions in relatively unique ways. Therefore, it can be expected that the treatment of different type soils will require an understanding as to how those soils can be expected to respond under different conditions. The principles of earthwork treatment are basic, though, and we shall discuss these basic principles, then apply those principles to the various categories of soils we may encounter.

Moisture-Density Relations of Soils

The proper preparation of any site of any soil involves obtaining the proper moisture content and in-place density of that soil on the site.

Let's examine the characteristics of soils with regard to their physical ramifications. We can start by doing a little experimenting in our kitchen. We go outside and with our shovel get a coffee can full of soil. Let's say this soil has been baking in the sun and is relatively dry. We just pile that loose soil in the coffee can until the soil is level with the rim of the can. We then take a rod or hammer and pound on our soil sample in the can. We notice that the soil settles in the can and after rodding and pounding the soil for a while we can see that soil sample now takes up a lot less space. The level of the soil may be one or two inches lower than it was when we first started pounding on the soil. By this action, we have compacted the soil. The weight of the soil is the same, because nothing was removed from the can, and nothing was added to the can. However, the soil now takes up less space, or less volume.

Definition of Soil Density

We have changed the density of the soil by this action. Density of soil is defined by the weight of the soil in a given volume. Density is measure by the weight per unit volume. For example, we typically measure soil in terms of pounds per cubic foot. A soil that weighs 125 pounds per cubic foot (pcO has a higher density' than a soil that weights 110 pounds per cubic foot.

Let's get back to our coffee can soil sample. The weight of the soil in the can does not change. Let's say the soil weighs five pounds; but let's say the volume of the full coffee can is one cubic foot (this is not realistic, but I am trying to keep the numbers simple for this discussion). This means that the density of this soil would be five pounds per cubic foot (5 lb. divided by 1 cu.ft. = 5 lb/cu.ft.). After we pounded, or compacted that soil in the coffee can, the soil now is level at some distance down in the can. The compacted soil takes up less volume. Let's say the new volume is now 0.8 cubic feet. This means that the new density of this same soil would now be five pound in 0.8 cubic feet (5 lb./ 0.8 cu.ft. = 6.25 lb./cu.ft). The compacted soil sample has a higher density than the uncompacted soil sample.

Effect of Water in Soil

Now let's consider the effects of moisture on a soil's ability to be compacted. Water serves as a lubricant to compaction in soils.

By thoroughly mixing a proper amount of water in a soil sample, the soil can be compacted to a higher density than that same soil sample without the proper moisture.

The amount of moisture is important, though. Not enough water will not provide enough lubricant to all the soil particles to maximize optimal compaction conditions. Too much water, though, will in effect, flood the soil particles. At this point water starts to replace the soil particles, and maximum or optimal compaction cannot occur under those conditions. The key to proper and optimal conditions for soil compaction is to find the proper amount of water that a particular soil needs, properly mix that water into the soil, and then compact that soil with energy.

Finding Maximum Density at Optimum Moisture Content

Let's go back to the kitchen and experiment with our coffee can of soil. Note the level of the soil in the can after it has been compacted without the addition of water. Now remove the soil from the can and add water to the soil and mix it in. Replace the soil in the can, and compact that soil. Try to pound or compact the soil with the same effort or number of blows as you did the first time on the dry soil. Now note the level of the compacted soil with moisture in it. You will find the soil had been compacted to a new level that was lower than the dry compacted soil. This soil takes up less volume for the same amount of weight. This means the soil has increased in density.

Experiment further with the soil with increasing amounts of water mixed into the soil. You will find that the volume of the compacted soil continues to decrease with each addition of water up to a point. However, you will find that after adding so much water, the volume will go up. At this point, water has begun to replace the soil, and the soil/water combination now takes up more volume than soil with a content of water. The soil sample with the lowest volume indicates the maximum optimal compaction. The amount of water in the soil at this point is noted. This moisture content is the soil's optimum moisture content.

Different Density / Moisture Contents for Different Type Soils-

As we have previously noted, the water in the soil acts as a lubricant to the particles of soil to affect the soil's ability to be compacted. We have learned that the size of the soil's particles help determine the way we classify soil by the Unified Soils Classification System. It stands to reason, then, that soils with different particle sizes will react differently to different levels of soil water content.

Since sands and gravels contain larger particles, less water is necessary to lubricate those particles. A soil with small particles have more surface area that would need to be lubricated than soil with large particles. This means, then, that sands and gravels require less water per unit volume to obtain optimum moisture for compaction than do soils of smaller particle sizes, such as clays.

Clays, as we have learned, have particle sizes that are microscopic. This means that more water is needed to lubricate the particles in clays. Since more water is needed for clays, it stands to reason that the maximum compacted density of clays will be less than that of the sands and gravels.

This all means that every type soil has its own unique maximum density and optimum moisture content for proper compaction. Generally, sandy soils have heavier maximum density values than clay, but at lower moisture contents than clays.

Different Soils Require Different Treatment

Every soil type must be treated in its own unique manner to obtain proper compaction on the site. Clay soils tend to be more difficult to mix in the proper moisture than sandy soils because clay soils don't readily break up for the assimilation of moisture evenly throughout the soil; and since clays are relatively impermeable, it is more difficult to thoroughly mix soil throughout the soil without breaking it up into very small particles. Clays can be difficult to work with; and fat clays are more difficult to process than lean clays. Sandy soils usually break up easily under kneading action, and since they are more permeable, mix with water more easily and thoroughly, thus making sands usually more workable.

In-Place Density/Moisture Content of Soils on the Jobsite

For any project where earthwork is involved, and soils are to be compacted to optimum conditions, it is important to properly monitor the compactive effort and moisture contents of those soils.

Tests methods have been devised to provide for that monitoring activity. The soil in the field must be tested. Since we know that the maximum density and optimum moisture content of the soil is the most important information necessary to ensure proper compaction, we have tests that measure the in-place density and moisture content of that soil.

The in-place density and moisture content of the soil on the jobsite can be measured by various methods. The old-fashioned way to do this is to obtain a sample of the soil that has been compacted, then measure the hole that the sample was obtained from. The sample is then weighed, the moisture content of the sample is determined, and the in-place density of the soil is computed in a similar manner to the way we were doing in the kitchen earlier. The volume of hole is measured by various methods such as falling the hole with sand, then measuring the amount of sand left in the hole (this is the Sand Cone Method (ASTM D-1556) Note - ASTM stands for American Society of Testing Materials, and the number is the test designation number necessary for writing of job specifications), or by forcing a balloon device that fills the hole with a volume of water contained in the balloon, and the volume of the water is measured. The in-place density is computed in a similar manner (ASTM D-2167). The modern method of determining in-place soil density is by use of a nuclear densometer. This device automatically measures the density and moisture content of the soil by measuring and automatically calibrating the number of nuclear gamma rays that pass through a given volume of soil. The more gamma rays that get through mean the lower the density of the soil. It works kind of like an X-Ray. This method is known as the nuclear densometer method (ASTM D-2922).

Moisture-Density Relations of Soils

The jobsite in-place density test is of little use unless we know the maximum density and optimum moisture content for a particular soil. For this reason, the American Society of Testing Materials (ASTM) has devised test methods for determining the maximum density and optimum moisture content for soils.

The methods are very similar to our kitchen soil density experiment. The test is called the Moisture-Density Relations of Soil, or often called the "Proctor" test. The test is performed in the laboratory on a loose sample of the soil being used for the embankment construction. The test is very simple. The technician mixes different amounts of moisture in the sample and compacts the soil using a ram of a given weight over a given number of blows to the sample. This results in a series of soil density values for each different soil moisture content. A curve is drawn to show which combination of soil and moisture provides the maximum possible density for that soil. The result is the maximum soil density at the optimum soil moisture content.

Standard/Modified Moisture Density Relations of Soils

Different compaction standards exist in the American Society of Testing Materials. Each moisture density relations of soils test method employs a different amount of compactive energy. The primary tests used by the construction industry are the "Standard Proctor (ASTM D-698)" and the "Modified Proctor (ASTM D-1557)". The Standard Proctor dictates a ram that weighs 5.5 pounds that falls 12" in three lifts of soil. The Modified Proctor dictates a ram that weighs 10 pounds that falls 18" in five lifts of soil. This essentially means that the Standard Proctor requires less compactive effort than the Modified Proctor.

So if a job specifies the Modified Proctor, the embankment soil will be compacted at a higher maximum in-place density with lower moisture content than would a project that specifies the Standard Proctor. The typical job specifies that the jobsite in-place densities must meet a minimum percentage of the specified Proctor test. For example, it is common that job specifications require a minimum compaction of 95% based on the Standard Proctor. Often, the job specifications also require a limit on the allowable moisture content. For example the jobsite specifications may state that a minimum in-place density meet at least 95% of the Standard Proctor within plus or minus 3% optimum moisture content.

As would be expected, it is much more difficult to obtain 95% maximum density on soils that are specified to meet the Modified Proctor than would be expected for the Standard Proctor. Many contractors who did not understand the significance of building embankment to meet Modified Proctor requirements find themselves in trouble when they cannot obtain the required density.

Typically, the Modified Proctor will be specified on projects where heavy industrial loads or vibrating loads call for very strong soils. Generally, soils compacted as per Modified Proctor standards will be stronger, tighter, and less likely to settle. On the other hand, fat clay soils that are placed using the Modified Proctor for lightly loaded structures are more likely to swell if wetted. Proper care should be taken during the writing of job specifications to ensure the proper standard is applied to a particular job application.

A Unique Moisture-Density Relations for Each Soil

As previously noted, every soil that is used for embankment construction has its own unique maximum density or optimum moisture content regardless of whether the Standard or Modified Proctor is used.

The fat clays will require more water, but will have lower maximum soil density values. Sandy soils will require less water and will have higher maximum density values. Granular soils require a completely different test method called the "Relative Density" test.

The point is that every site and every soil borrow source shall require its own unique maximum density and optimum moisture content value.

The variability of soils on any site is often a source of argument and disagreement on the jobsite. It is important that the contractor, the owner, and the testing agency be cognizant of possible changes in soils as a project progresses in its embankment construction. Soils can vary from site to site, and even at different depths in a soil borrow pit. It is important that all parties be aware of this possible variability.

For example, it is possible that the embankment soil at the beginning of a project is considered to be clayey sand which requires less water and has a relatively high maximum density. As the borrow pit is excavated, the soil could become less sandy and more clayey, but still have a similar visual appearance. Meanwhile, the contractor is finding that he cannot compact the soil enough to obtain the minimum allowable density. It is possible that the soil has changed enough so that the new soil would have a lower maximum density at a higher moisture content, which would happen if the soil became more clayey.

Should tests start to fail, or conversely be very high, for no apparent reason, and the soil processing and compactive effort not change, then it is possible that the soil has changed, and the Proctor value should be checked for possible change by the laboratory.

On any embankment construction jobsite, all parties involved should assume the responsibility of helping to assure the proper Proctor test standard is being used for the appropriate soil.

JOBSITE PREPARATION

Few sites exist that are ready to build upon. Most sites require some type of preparation or modification prior to the placement of any foundation system.

The most simple and least expensive preparation is just the removal of on-site vegetation with moderate leveling. This may be all that is required in some circumstances. However, should the site consist of dry, fat clays, problems may result. Should the site consist of dry loose sands, problems can result. Generally, building on a site in its natural state is inferior to almost any type of site modification. Exceptions do exist, but in most cases, some thought over site improvement or modification may serve very well to the overall structure performance.

Preparations on Level Sites or Clayey Soils

It is common practice to simply grade off a site and begin excavating for footings and plumbing. However, if the soil consists of dry and stiff fat clays, the possibility of problems down the road exists as previously discussed. Some of the danger of future problems can be minimized by proper site preparation. During this effort, the drainage conditions of the site can be improved.

The swell potential of dry and stiff fat clays can be reduced by mixing water in these soils, followed by recompaction at maximum density at moisture near optimum moisture content. The act of mixing fat and dry clays with water serves to stabilize the soil and to help seal the soil from excessive intrusions of moisture that eventually result in swelling and weakening of the soils.

Oftentimes it is not practical to perform this reprocessing of the soils to depths greater than one foot, but the deeper the better, and every little bit of improvement helps. The same conditions for lean clays would apply, but as previously noted, lean clays do not present as severe a problem as fat clays.

Preparations of Non-Level or Site Requiring Embankment Fill

Oftentimes it is necessary to adjust the grading of the site. First of all, on any site that is to be leveled using embankment soils, it is important to place all embankment soils on level layers. Any sloping site should be terraced prior to embankment construction to ensure level layers for the embankment soil.

All areas to receive embankment fill soil should be examined for proper soil stiffness, uniformity, and clear of vegetation. Often, it is necessary to process the natural soils for maximum density and optimum moisture content prior to placement of embankment fill soil. Recompaction of the exposed soils in the excavated portion of the site is advisable because this will cause the entire site to be more uniform.

Prior to construction, the proper standard or Proctor of the embankment construction needs to be specified (we will discuss job specifications later in this booklet). A sample of the soil to be used should be delivered to the laboratory so the maximum density and optimum moisture content for the embankment soil can be determined.

The job specifications should also dictate the type of soils that can be used for the embankment construction. The soil's sieve analysis and Atterburg limits, or in other words, the soil's classification as per the Unified Soils Classification System should be determined for compliance to job specification. For example, the placing of very permeable granular sand fill over very fat impermeable clay could set up a perched water zone situation over the construction. We will talk about this in greater detail later in this booklet. Or for another example, it would not be wise to place a fat clay embankment fill soil over a nice clayey sand site, because this would degrade the quality of the site for the new construction. As the embankment construction begins, the first few lifts of the embankment construction should be closely monitored by performing numerous in-place soil density and moisture contents to help the contractor ensure he's got a good process and compaction method for the soil and the site. Thereafter, enough testing should be performed to ensure the work progresses as per job requirements. The embankment construction should typically not be placed in lifts greater than 8" to 12". This depends on the initial conditions of the soil and the equipment used to compact the soil. The smaller the compaction equipment, the thinner the lifts need to be.

Comments on the Types of Soils Used for Embankment Construction

Rocks and Gravels - Generally, use of rocks and gravels for embankment fill can result in excellent embankment construction. However, the grading and size combinations of the rock and gravel must be of such a nature that no voids in the embankment construction are left. Good mixtures of rock, gravel, sand, and soil can be placed in relatively thick lifts if no voids are allowed to be present. However, such soils are poor for fine grading, so when the final grade is approached, more finely graded materials will be required. Unfortunately, it is not possible to properly test rock fill for proper compaction. The best way to monitor such work is to continually observe to ensure that a well graded material is placed and that no voids remain. No flat rocks should be placed—other than flat, large boulders must be filled in with smaller materials, etc.

Sands - Properly placed, sands are excellent materials for embankment construction. Sands are easily worked for mixing of water, and require little processing for the obtaining of maximum density. Non-cohesive sands can be a problem for equipment that has relatively concentrated, heavy loadings such as small-tired trucks. Small heavily-loaded tires tend to rut in sands and can become stuck. Sands are excellent structural materials when confined, but can be difficult to deal with when near the surface or in a condition of non-confinement. Trenching for foundations and plumbing can be a problem in non-cohesive sands. Sands must be used with care where steep slopes and possible problems with erosion exist.

Thin sand embankments should not be used over impermeable clay bearing soils. The sands will tend to collect incidental moisture. The moisture will not harm the sand normally. However, the presence of moisture in the sand above an impermeable clay layer can lead to problems as the clay layers are continuously exposed to the moisture in the overlying sands. The same condition would occur for trenches that are backfilled in a clayey soil environment. Sand filled trenches may collect incidental moisture, which could act to damage the adjoining clayey soil layers.

Silty soils must be dealt with in a similar manner to that of sands. There are very few soil formations that are pure silt. Silt is normally combined with clays or coarser sands. Usually, embankment construction using pure silts should be avoided except when it is placed at greater depths. Silts usually are difficult to work in because it is hard to establish a working "body" in the silt strata, and the strength in silts is difficult to obtain.

Lean Clays - Generally, lean clays can be considered one of the more versatile soil types for embankment construction. They take more effort than sands to process for proper compaction, but not excessively. Lean clays, once properly placed and compacted make excellent trenching soils. They can have a very sound texture on the compacted embankment fill which provides for excellent working platforms. Lean clays can be placed over most any type of soil strata without notable concern as the effect of the clays on the underlying strata. Lean clays are usually inert trench backfill soils.

Lean clay embankment fills, though, are not very forgiving if not properly processed or compacted. Sands can be adequately compacted at a large margin of moisture contents. But lean clays react more critically to variable soil moisture contents. Improperly placed and poorly compacted lean clays can cause grief with swelling and uplifting soils.

Fat Clays - Some of the hazards of using fat clays for a building site have been previously mentioned. Using fat clays for embankment fill is not typically desirable for normal construction requirements. However, sometimes no choice exists. It is possible, though, that the fat clays can be satisfactory if used on properly compacted underlayers while using leaner clays to top the work out. The principles of proper processing of the soils for thorough mixing of the soil with water for optimum moisture content is critical with fat clays. Done properly, fat clays may almost perform satisfactorily.

Typically, it is more difficult to mix and process fat clays, and the compaction effort and water mixing are more critical for fat clays than other soil types.

Fat clays are good whenever some type of water retention structure is required. As previously noted, fat clays are relatively impermeable. Pond liners, dam cores, waste holding ponds, and dikes often need soils that are relatively impermeable to prevent leakage of water retention structures. Of course, proper compaction of any water retention structure made of fat clays is imperative.

Structural Backfill Construction

Backfill areas usually require special consideration. Typically, backfill areas are small and difficult to compact. However, poorly compacted backfill areas often are the source of settlement and underground drainage problems. All foundation backfill should be compacted using on-site or similar soils. These soils for backfill should be properly compacted as noted earlier in this report. Improper compaction of backfill can lead to soft and saturated backfill that may either shrink or swell. This can be a particular problem on backfill around the interior columns, interior grade beams, inside of exterior grade beams, and underground utilities that run near and parallel to walls and structures.

Drainage Considerations

Proper site drainage both during and after construction is important to ensure that excessive moisture does not cause the weakening of soil structure or the possibility of movement by swelling. Many problems with movement of structural foundations are a result of variations of soil moisture contents from season to season or by changes in the moisture of the soil by site re-configuration. The maintenance of constant in-situ soil moisture contents in the vicinity of foundations and floor slabs-on-grade should help minimize these problems.

Using Embankment Fills to Improve Site Conditions

Sometimes a natural site is a poor site for foundation purposes. The site could be in an area where the static subsurface water table is near the surface, and the soil strata is very soft and weak. The site could consist of fat clays, and it may be desired to isolate the foundation from the fat clays. Perhaps the site is too low-lying, and it is desired to bring the elevation to a higher level.

Oftentimes, it is desirable to remove the existing loose or soft soil on a site to be followed by recompaction of these soils or imported superior soils down to depths that essentially provide a well compacted, improved site.

The embankment fill soil accomplishes two tasks under these circumstances. First, a workable base for the new construction has been established. Smaller footings can typically be utilized. The embankment fill soil acts to bridge over the soft areas. It's similar to a boat placed on a sea. The embankment fill literally floats on the underlying weaker soil, and carries the more concentrated loads of the structure. Second, the embankment acts to spread these loads out so that the influence on the underlying weaker soils is minimized.

The embankment soils do, however, represent considerable weight. It is probable that the embankment fill soil will settle into the weaker soil strata. If the weaker soil is a compressible fat clay as previously described, this settlement or consolidation process could take years. Therefore, any time an embankment soil is used to improve a site; the ramifications of that fill on the underlying weaker soils require some type of consideration. It may serve well to monitor the embankment fill soil for a period of time after it is placed to see if it is undergoing some type of settlement. Should the underlying weaker strata be a sandy soil, it is probable that most of the settlement will occur as the embankment fill soil is being placed.

FOUNDATIONS/FOUNDATION DESIGN

If everything up to this point has been done properly with regard to initial site preparation, then any foundation should perform adequately. However, it is not prudent to depend exclusively on the site preparation. This is why considerable thought and effort should go into any foundation design.

Anyone can design a foundation system that will work. The idea is to design a foundation system that is conservatively prudent, that considers the possibility of unanticipated site stress, that considers the foundation/soil interaction, and that is as low-cost as possible.

Foundation Systems

A discussion of a few of the basic foundation systems and the sites and types of construction that would use these foundations systems are considered as follows:

Perimeter Grade Beam/Slab-on grade

This type of foundation system is probably the most common and (hopefully) the least expensive of all foundation designs. The typical residential and light commercial footing system is this type.

Usually, this type of foundation system is adequate and relatively easy and cheap to build. Unfortunately, it is the type of foundation system that is liable to experience the greatest problems if the original site is poor and/or the site preparation is inadequate. The quality and viability of this type of foundation system, of course, depends on the thought utilized by the designer to match the anticipated possible soil actions to the design of the foundation features.

Normally, a city code dictates the minimum perimeter grade beam/slab-on-grade system. The perimeter grade beam usually must be below frost depth (1.5' to 3.0'), and it must have some reinforcing steel longitudinally and vertically. The slab-on-grade usually must be 3.511 to 4.011 and be underlain with sand or base. Usually, at least wire mesh steel is required to be embedded in the slab. City codes often dictate the minimal site preparations such as proper compaction of the bearing soil. Usually, the perimeter grade beam is formed by a trench excavation, and no backfill is performed after concrete placement.

It is common that the slab under the interior bearing walls of a light structure will not provide for additional support. In other words, it often occurs that interior walls that help support the roof and ceiling are supported only by the unthickened slab-on-grade.

The above describes a minimal perimeter grade beam with slab-on-grade as would often be a minimal requirement in a city code.

The quality and complexity of perimeter grade beam/slab-on-grade foundations can increase. However, it has been my experience that the cost does not increase in proportion to the quality of these type footings. I have found that only a small additional cost and small additional thought and consideration can do wonders to improve the quality of these foundation systems.

For example, use of a slab thickening of six to eight inches along with longitudinal steel beneath all interior walls will add significant stiffness and integrity to the foundation with only minimal cost additions and basically no additional labor. By thickening the slab-on-grade by one inch and by use of small diameter reinforcing steel versus wire mesh one can add considerably to the stiffness of a slab-on-grade, and the additional cost is small in proportion to the additional quality of the system.

A well-designed perimeter grade beam combined with interior grade beams as once required by HUD are excellent, very stiff, and almost invulnerable foundation systems, and the cost of these systems, even though somewhat higher, are still proportionally low as compared with the received product. It is true that the plumbing is more difficult with such systems, but the extra trouble is often worth the effort.

Another type of perimeter grade beam/slab-on-grade system is the post-tensioned slab construction system. These foundation systems are very efficient and effective foundation systems. Special skills and design knowledge are required for such systems. If the installer has these skills and knowledge, the system is excellent. If the system is designed and installed by someone less knowledgeable, the system can be worse than no system at all.

Residential Pier-and-beam

Typically, a residential pier-and-beam type structure consists of a perimeter grade beam that extends around the house and is deep enough to penetrate the frost zone of the soil. The perimeter grade beam is configured in a similar manner to the perimeter grade beam on slab-on-grade systems. Interior piers typically consist of about ten inch diameter concrete pedestals that penetrate one foot or more into the soil subgrade. These interior piers are typically spaced at six to seven foot intervals. Interior piers can be substituted by using interior grade beams. The flooring is typically wood. However, it is possible to design these structures with structural slabs, or self supporting slabs. These type structures can use either interior piers or interior grade beams.

Usually, these type footings are relatively safe from soil uplift problems except in extreme cases. The primary foundation movements I have observed with pier-and-beam footings are when severe plumbing leaks have caused flooding in the subfloor, and the soil beneath the interior piers have been weakened. Under these circumstances, the relatively heavily loaded piers have settled.

Shallow Spread Footings with Slab-on-grade

Commercial and light industrial single-story structures that are to be built on relatively good and consistent sites or on properly placed embankment fill soils often use a shallow spread footing with floor slab-on-grade.

The same basic principles that apply to the above-noted perimeter grade beam/slab-on-grade system for lightly loaded residential and small commercial structures are essentially the same for this type of foundation design system.

Usually, the perimeter footings for these larger structures (warehouses, large discount stores, supermarket buildings, mall structures, etc.) consist of spread footings placed two to five feet below the surface. These spread footings support a stem wall of typically eight to ten inches in width.

It is normally necessary to backfill adjacent to the stem wall over the spread footing on both the inside and outside of the building wall. This backfill must be placed as per adequate compaction and moisture content requirements just as any embankment fill soil would require. Failure to properly compact these backfill soils will result in settling and/or uplifting of soils adjacent to the stem walls.

Typically, these structures require column footings on the interior of the structure. If the exterior footings consist of shallow spread footings, it is probable that the interior column footings shall also be shallow spread footings.

The slab-on-grade on these structures are usually, but not necessarily, reinforced with small diameter reinforcing steel running in two directions. The slab at the perimeter can either rest directly on the stem wall, or it can be placed adjacent to the stem wall. Reinforcing steel or dowels are usually placed between slab and the stem wall to ensure horizontal or vertical displacement does not occur between the slab and the stemwall. Such differential displacements could result in cracks in masonry and adjacent walls.

The interior columns are usually separated from the slab-on-grade with a construction joint. However, dowels or reinforcing steel ties the slab to the column's footing to ensure no vertical displacement occurs between the slab and the column footing. Sometimes, the column footing and the slab-on-grade are designed monolithically. However, such a design can result in some cracking in the slab should the columns flex under wind loads, etc.

General Comments Regarding Slabs-on-grade

Typically, a sand or porous underfill layer of about 4" depth is used for non-engineered slab-on-grade. Vapor barriers beneath the slab or sand layer are a matter of discussion. Some buildings use no vapor barrier, and no evidence exists, except in extreme circumstances of flooding of the subgrade, that we know of that shows a problem with moisture rising from the subgrade through the concrete slab. Usually, the subgrade soils are not exposed to sub-slab moisture from natural occurrences at the typical site that is not exposed to water near the subgrade level. Many structures have used a plastic vapor barrier both over and below the sand layer. The vapor barrier over the sand tends to keep the work area more clean, and prevents evaporation of moisture from the fresh concrete to improperly dampen the sand base (this will result in significant slab shrinkage cracking). However, if the placed concrete is too wet, the vapor barrier will prevent the absorption of excess moisture into the sand, and the concrete will be weakened, and cracks will result. Essentially, the designer needs to determine for himself which method he prefers; advantages and disadvantages exist either way. The use of the moisture barrier beneath the sand layer, and being certain that the sand base is properly dampened during the placement of concrete is probably the most preferable.

Multi-Story Spread Footings

Spread footings or spot footings are often used on sites where multi-story structures are to be supported. Site preparation is not normally an issue for these structures, because it is common that these structure's foundations will be excavated deep into the natural soils. These footing designs are used when the site is a relatively sound site with little variability. Spread footings are also typically used when the soil strata consists of dense sands. It is important that the load intensity on these type structures be relatively consistent to avoid variable stress on the structure caused by differential settlement. These type footing rely primarily on the underlying soils for support. If these footings are sufficiently deep below the surface, the bearing capacity on these footings is increased due to the support of the adjacent overburden soils. Oftentimes, these structures will have slab-on-grade at the lower levels or ground level. Slabs-on-grade of these structures are usually tied with reinforcement, but hardly ever are they placed monolithically so that structural stresses are not passed on to the floor slab-on-grade.

Drilled Pier Foundations

Drilled pier foundation systems are popular in commercial, industrial, multi-story, and bridge structures. Drilled piers are installed by using drilling excavation equipment, then the shafts are steel reinforced, then are filled with concrete.

It may or not be required to case the pier shafts. Firm and cohesive clayey type soils usually will stand unsupported for short periods of time. When non-cohesive sands are on the site, or if the soil strata above the bearing depths are weak and cannot support vertical walls, then pier casing is required. Drilled piers can be designed so a "ream" or a "bell" can be placed at the bearing surface of the pier. This provides for a greater effective bearing area for the pier, and for added uplift resistance using only small additional quantities of concrete. Of course, the soil strata must be capable of supporting itself unless additional support such as a slurry backfill is used. Drilled piers are a versatile footing design. Structural bearing support can be gained from both the end bearing at the bottom of the pier, and the side wall friction of the pier can provide some structural support. Drilled piers can be used when the initial site preparation or the site conditions near the surface are marginal. For the additional concrete called for by drilled piers, one gets a pretty good bang for his buck.

Use of drilled piers is not typically advisable when the soil strata consist of loose sands. Drilled piers tend to provide relatively heavy and concentrated structural loads on a soil. Loose sands should not be loaded with heavy concentrated loadings, because a phenomena known as "Plunging" can occur. This means that a pier heavily loaded in a loose sand can "punch" downward until the surrounding sands are densified enough to stop the settling action.

Driven Piling Foundations

A driven pile foundation system requires specialized equipment and a capable crew to be properly placed. However, driven piling foundations can be very efficient, dependable, and versatile foundation designs.

A driven pile consists of a treated wood, reinforced concrete, or steel shaft (tube, square, H shaped, etc) that is driven into the ground by a power driven ram. The pile can be driven into a pre-cut pilot hole, or it can be driven into previously undisturbed ground.

The penetration rate of the driven pile provides a good measure of how much resistance that pile can be expected to bear for structural bearing. In other words, the number of ram blows required to drive the pile a given distance down provides information as to how much loading that pile can be expected to withstand. A major advantage of driven piling is in the fact that piling can be continually driven until penetration bearing is obtained. In the case of steel piling, the piles can be added indermitely to by welding additional lengths until bearing is obtained.

Driving piling in a group in an area tends to densify the soil in the immediate vicinity of the pile group. This means that properly driven piling not only provide good support for a structure, they also improve the strength of the soil in the vicinity of the pile group. Driven piling can be very effective in loose sand strata, primarily due to the densification action of combined pile groups. Care in driving is required though if large rocks or boulders exist in the strata. The driving action can damage the piles when the rocks are encountered or the penetration resistance information can be false if subsurface boulders fall in the path of the driven pile.

Whenever bedrock exists below a poor or marginal site, use of driven piling can be very useful. This is particularly true in areas where the surface soils are incompetent or water laden such is often the case in areas adjacent to rivers or bays where bridges are placed. Many bridges use driven piling for their foundation support. Sheet piling is often used to provide retaining wall or water retention structural support. Sheet piles are similar to regular piles, except that they are wide and are tied together side by side as they are driven, thus providing a wall to serve as a retaining structure.

Driven piling can lose credibility when used in soft clays. Unless a sound layer of clay or rock is encountered, it may be difficult to obtain penetration resistance in soft clay strata. This is because the driving action of the piling tends to drive up the water pressure in the soil in the vicinity of the pile, and this water, or pore pressure, weakens the soil. However, by allowing the pile to rest for a period of time, the pore water pressure dissipates, and the clayey soils adjacent to the pile regain strength to some degree. This is why a pile can be driven and penetration not obtained, left overnight, then the driving continues to find penetration obtained in the first few blows. Continued driving will result in "breaking through" though, and penetration resistance falls again. Static load tests on these piles are sometimes required.

Mat Foundations

Mat-type foundations can be very useful and versatile where the sites are marginal and the structure is such that it can be designed to act as one unit. A mat foundation consists of a thick slab of reinforced concrete that can structurally support all of the structure and its supports. The structural loading is distributed into the mat so that the soil loadings are uniform across the structure. The size of the mat is designed so that the nonuniform structural loads are eventually distributed on the soil evenly. A mat footing is used often for multi-story buildings, for tower structures, and for heavy industrial structures where many heavy, variable, and vibrating loads are anticipated. Mat-type foundations can be expensive, but they can be designed to be virtually indestructible.

Raft Foundations

A raft foundation is structurally similar to a mat foundation. The raft structure is designed monolithically in a similar manner to that of the mat foundation. However, the raft foundation is essentially a "hollow" mat foundation. Instead of the mat being composed of solid concrete and steel, the raft foundation system is designed similar to that of the hull of a ship.

A raft foundation system essentially "floats" on the soil strata. The foundations on a raft system utilizes the "buoyancy" of the soil to support it. Since the raft foundation is "hollow" such as a ship floating on water, the raft structure's relative weight per unit volume of space within the raft structure is very low. As a result, it can float. This type of foundation system is useful in loose sands, or where the static water level is near the surface. The ultimate unit loadings of a raft foundation system are typically very low, and the system can be used on almost any type site. However, the structural requirements and loadings on the individual components of the raft foundation system are high. This means significant structure and reinforcing inside the raft structure.

Combined Foundation Systems

Good foundation engineering design often combines one or more of the above noted foundation systems to provide the least expensive and most dependable foundation system. A thorough knowledge of both structural reactions and soil-to-structure interface is essential in any well engineered foundation design system. However, great savings of time and money may be at hand if sufficient thought and attention are provide for the most efficient and safe foundation design system.

For example, a combination that comes to mind is the combination of a mat and a drilled pier foundation system for a heavily loaded structure such as a bulk material containment structure such as a grain silo. Such a system would be very useful where near-surface soil is fair to marginal while the underlying soils at, say, the twenty foot depth are very sound. Such a foundation system could take advantage of the marginal surface soils while being enhanced by the underlying pier footings.

Most structures could probably be improved with lower costs by an appropriate combination of different foundation styles. Only the limits of the imagination of a knowledgeable foundation designer will dictate.

Specialty Foundations

Most specialty foundations are nothing more than basic foundation systems that are placed by special methods or that use special materials. These type systems are called for when the site conditions dictate more than ordinary methods. Some of these methods are conducive to existing foundations in need of repair or remediation. A few examples with brief descriptions are provided as follows:

Hollow Auger Pier Systems - Oftentimes it is desired to place drilled piers, but the soil strata is either below the static water surface or the soils are otherwise incompetent. A hollow auger pier system drills down through the soil to the bearing depth. At the bearing depth, the hollow auger is filled with concrete or grout under pressure. The auger is slowly extruded from the excavation. As auger is extruded, the pressurized concrete or grout is forced into the space made available as the auger is extruded. Once the auger is removed, reinforcing steel is pushed down into the cemented hole, thus resulting in a reinforced pier.

Helical Piers - Helical piers are often used to help underpin in-place structures that are in need of additional support or remediation. A helical pier is a form of permanently installed auger that is drilled into the ground until it refuses to auger further. This friction resistance acts to provide bearing support. These systems are relatively versatile in that they can be used in loose sands, soft clays, water bearing strata, and in just about any strata that allows some depth of penetration before refusal.

Hydraulic Pipe Piers- Hydraulic pipe piers behave in a similar manner to helical piers. Hydraulic pipe piers are placed by forcing pipe into the soil strata using hydraulic rams until refusal is obtained. These systems work well on residential structures that are in need of

leveling as well as underpinning. The system can bring the foundation to the desired elevation as the system drives the pipe pier into the soil.

Pressure Grouting - Some sites can be improved by improving underlying soil strata in place. A good example would be a loose sandy soil strata where it is intended to place large loads. By pressure-injecting a strength-enhancing agent such as Portland cement over a grid of a given area, the loose sand can be converted to a huge block of lean concrete. Such applications are very limited in applicability.

I have seen such methods tried in firm clay soil sites with no success. It works in loose sands because the sands readily absorb the cement and water mixture in the area surrounding the probe. Under such circumstances, the system is effective. In a clayey circumstance, the system may do more harm than good. Each case must be evaluated and considered based on the soil strata and the proposed grout agent.

Designed Site Drainage

A common requirement for all foundation designs is proper site drainage. Most problems that occur to foundations are the result of poor drainage or from water accumulating around foundation systems. In most circumstances, a simple positive grading around the structure should be sufficient. Any irrigated landscaping should be designed in such a manner that the foundation system is not needlessly wetted.

In areas where the subsurface water levels intersect the structure's foundations, use of subsurface drainage systems such as "French drains" or other static water pressure relief may be necessary. Backfill of trench, basement, or footing excavations with sandy soils in a clayey soil environment can cause poor subsurface drainage if not properly sealed from moisture intrusion. It must always be remembered that a new structure of any kind on a site means that the conditions of that site are being changed. It is probable that the changes on the site will change the conditions to new conditions which the foundation soil strata has not previously encountered. These changes could affect the physical characteristics of the foundation soil strata. These possible changes should be anticipated and dealt with as a part of the design process. All efforts possible should be made to minimize the changes to which the site soil strata are to be subjected.

INSPECTION AND TESTING OF FOUNDATION STRUCTURE CONSTRUCTION

The best site preparation plan and foundation design is of no value unless the site preparation and the foundation installation is done according to that plan. A well conceived plan and specification for the construction of these features is a prerequisite to a properly constructed project. Most of the failures I have observed with foundation systems are not typically the result of improper design. Most failures are the result of short cuts in the installation of the structure, which is often, in turn, the result of a poor set of specifications which are ignored. Proper inspection and testing of all phases of the site preparation and foundation placement are paramount. When site preparation includes embankment construction, proper testing and monitoring of all phases of the embankment construction are essential. Job specifications must detail the necessary soil types and compaction requirements for all embankment construction procedures. Preparations for foundation installations are subject to poor practice and abuse unless job specifications and on-going monitoring of the entire process of the foundation construction is maintained. The foundation form work and the reinforcement steel placement condition is critical to the proper construction of the foundation system.

All concrete slab work must be placed with great care unless you are willing to accept excessive cracking and poor durability. There is a great tendency on the jobsite for the concrete slab work to be placed at high water contents because wet concrete is more workable concrete. Wetted concrete is weak concrete, and wetted concrete tends to shrink and crack more readily than properly-proportioned concrete. However, without proper attention and monitoring effort, slab concrete will in all probability, be placed wetter than necessary.

"Quality in Construction - A Penny's Effort for a Pound's Value"

This the title of another booklet I have written that specifically discusses quality assurance on the construction project. For the sake of saving every penny, many owners do not want to pay for a penny's worth of quality assurance effort for a pound's worth of extra value. I've seen too many jobsite problems because of lack of proper quality assurance in the form of poor specifications, no provisions for inspection, and only minimal testing. These extra efforts are indeed very small costs to pay for the best chance you have for a high- value structure while it's being built.

If you do not already have a copy of this booklet, I urge you to obtain one before you plan your next project. I assure you, you will receive a pound's value for only a penny's effort!

CONCLUSION

I hope you have found this booklet informative and of value to you. The libraries are full of books on foundations and construction procedures. I'm sure there are some of them that are more informative than this booklet. However, I have tried to relate my experience in the field of soils, foundations, and structures in terms that the person who must deal with foundation systems, but is not trained in soils engineering or foundation design can use and understand. I hope I have accomplished this task in this booklet. The knowledge I have accumulated over the years is the result of academic study and my own conclusions after observing many successful foundations and many failed foundations. Most of the credit, though, to my knowledge in this field must go to those hundreds and thousands of construction professionals for whom I have worked side by side for all these years. The jobsite supervisors, the equipment operators, the laborer on the wacker- packer, everyone with whom I've ever worked, these are the people whose corporate knowledge makes it all work, and I would be remiss if I didn't recognize them.

B.R. Tillery, P.E.

Recommended Practice for the Design of Residential Foundations

Version 2
(Adopted October 4, 2007)

**By the Texas Section
American Society of Civil Engineers**

© 2008 Texas Section – American Society of Civil Engineers. All rights reserved. Permission to make electronic or hard copies of this document for personal, non-commercial use is granted without fee, provided that no alterations, additions, or revisions are made to the document and that all copies of the document include this notice and attribution on the first page. Any other use of this document is strictly prohibited without prior written permission of the Texas Section-ASCE. To request permission, call 512-472-8905 or email office@texasce.org.

Foreword to Version 2

The Texas Section of the American Society of Civil Engineers (ASCE) adopted Guidelines (Version 1) for residential foundation engineering on October 3, 2002, with an effective date of January 01, 2003. Version 2, presented herein, was adopted on October 4, 2007. For reference, the following page presents specific changes to Version 2.

The Section began this work in 1999. This effort grew out of the response of many Section members to the Policy Advisory issued by the Texas Board of Professional Engineers (TBPE) in 1998, which addressed residential foundation engineering. Many ASCE practitioners expressed the opinion that technical guidelines should be created by a technical society such as ASCE rather than by the TBPE.

One committee and two subcommittees were formed to address the raised concerns. One subcommittee addressed the Evaluation and Repair of Residential Foundations (with their Guidelines presented in a separate document). The Residential Foundation Investigation and Design Subcommittee developed the attached document (Recommended Practice for the Design of Residential Foundations). The Residential Foundation Oversight Committee provided review guidance to the two previously mentioned subcommittees.

The three committees were composed entirely of Texas Section-ASCE members who were licensed engineers. The dollar value of the professional services donated by members of the Design of Residential Foundations Subcommittee to the effort is conservatively estimated to exceed \$1,000,000.

One goal of the combined Guidelines has been to provide the TBPE with guidance in their evaluation of complaints brought against engineers practicing residential foundation engineering. The Guidelines are not intended to be standards, but are guidelines only, reflecting the engineering opinions and practices of the committee members. They in no way replace the basic need for good engineering judgment based on appropriate education, experience, wisdom, and ethics in any particular engineering application. Thus, they are primarily suited as an aid for engineers.

Members of the Residential Foundation Investigation and Design Subcommittee (2007):

Philip G. King, PE, Chair

Gardner D. Atkinson, Jr., PhD, PE	Harry M. Coyle, PhD, PE	Robert P. Ringholz, PE
David A. Belcher, PE	David K. Isbell, PE	Michael A. Skoller, PE
Robert E. Bigham, PE	Kirby T. Meyer, PE	Kenneth M. Struzyk, PE
John W. Dougherty, PE	Toshi Nobi, PE	Harry P. Thompson, PE, RPLS
David A. Eastwood, PE	Gary A. Osborne, PE	Ed Van Riper, PE
Jim Epp, PE	Robert F. Pierry, Jr., PE	Daniel T. Williams, PE
Saad M. Hineidi, PE	Marius J. Mes, PhD, PE	

Members of the Residential Foundation Oversight Committee (2007):

Ottis C. Foster, PE, Chair

James G. Bierschwale, PE	Philip G. King, PE	Robert F. Pierry, Jr., PE
Dick Birdwell, PE	Richard W. Kistner, PE	Douglas S. Porter, Jr., PE
Edmundo R. Gonzalez, PE	Jerald W. Kunkel, PE	John T. Wall, PE
Richard C. Hale, PE	Steven R. Neely, PE	W. Tom Witherspoon, PhD, PE

The following lists the changes incorporated into Version 2:

Item 1. Section 2. DEFINITION OF “ENGINEERED FOUNDATION”

“a. geotechnical engineering information”

Changed to

“a. geotechnical information supplied by a licensed engineer”

Item 2. Section 4. GEOTECHNICAL INVESTIGATION, 4.1 Minimum Field Investigation Program

“Field logs shall note inclusions, such as roots, organics, fill, calcareous nodules, gravel and man-made materials. If encountered, the depth to water shall be logged. If the geology or site conditions indicate, overnight water levels shall be recorded prior to backfilling boreholes. Additional measurements shall be taken at the directions of the geotechnical engineer.”

Changed to

“Field logs shall note inclusions, such as roots, organics, fill, calcareous nodules, gravel and man-made materials. The presence or absence of free water in the borehole shall be noted. If encountered, the depth to water shall be logged. Additional water level measurements shall be taken at the discretion of the geotechnical engineer.”

Item 3. Section 4. GEOTECHNICAL INVESTIGATION, Subsection 4.3.3.1

“a. Potential Vertical Rise (PVR) as determined by the Texas Department of Transportation Method 124-E, dry conditions”

Changed to

“a. Potential Vertical Rise (PVR) as determined by the Texas Department of Transportation Method 124-E, using soil moisture conditions from dry to wet. The average vertical stress in the soil layers should be used in the calculations to derive the PVR”

Item 4. Section 5. DESIGN OF FOUNDATIONS, Subsection 5.1 Design Information

“e. special requirements of the project”

Changed to

“e. special project requirements”

Item 5. Section 5. DESIGN OF FOUNDATIONS, Subsection 5.2.2.3 PTI

“c. Maintain the calculated prestress eccentricity within 5.0 inches. Bottom beam reinforcing should always be used.”

Changed to

“c. Maintain the calculated prestress eccentricity within 5.0 inches. Bottom beam tendons or rebar reinforcing should always be used.”

Item 6. Section 5. DESIGN OF FOUNDATIONS, Subsection 5.2.2.4 WRI

“c. The minimum design length (L_c) shall be increased by a factor of 1.5 with a minimum increased length of 6 ft.”

Changed to

“c. The minimum design length (L_c) shall be 6 ft.”

Item 7. Section 5. DESIGN OF FOUNDATIONS, Subsection 5.5.1

“Plans shall be signed and sealed by the engineer of record, and be specific for each site or lot location. Plans shall identify the client’s name, and engineer’s name, address and telephone number; and the source and description of the geotechnical data.”

Changed to

“Plans shall be signed and sealed by the engineer of record, and be specific for each site or lot location. Plans shall identify the client’s name, the engineer’s name, address and telephone number; and the source of the geotechnical data.”

Item 8. Section 5. DESIGN OF FOUNDATIONS, Subsection 5.5.3

“e. the schedule of required construction observations and testing.”

Changed to

“e. a listing of the required construction observations and testing.”

Item 9. Section 6. CONSTRUCTION PHASE OBSERVATIONS, Subsection 6.3 Compliance Letter

“6.3.1 At the satisfactory accomplishment of all the requirements of the plans”...etc.

Changed to

“6.3.1 At the satisfactory accomplishment of the requirements of the plans”...etc.

Table of Contents

Section 1. Introduction	1
1.1 Objective	1
1.2 Limitation	1
1.3 Adopted Changes	2
Section 2. Definition of “Engineered Foundation”	3
Section 3. Design Professionals' Roles and Responsibilities.....	4
3.1 Geotechnical Services.....	4
3.2 Design Services.....	4
3.3 Construction Phase Services.....	4
Section 4. Geotechnical Investigation.....	5
4.1 Minimum Field Investigation Program	5
4.2 Minimum Laboratory Testing Program	6
4.3 Geotechnical Report.....	6
Section 5. Design of Foundations.....	9
5.1 Design Information	9
5.2 Design Procedures for Slab on Ground.....	9
5.3 Design Procedures for Structurally Suspended Foundations	11
5.4 Design Procedures for Footing Supported Foundations.....	11
5.5 Minimum Foundation Plan and Specification Information.....	11
Section 6. Construction Phase Observation	13
6.1 Responsibility for Observations	13
6.2 Minimum Program of Observation and Testing	13
6.3 Compliance Letter	13
APPENDIX A.....	14
APPENDIX B.....	16
Section B.1 FILL	16
B.1.1 Engineered Fill.....	16
B.1.2 Forming Fill.....	17
B.1.3 Uncontrolled Fill.....	17
Section B.2 Building on Non-Engineered (Forming Or Uncontrolled) Fill.....	17

Recommended Practice for the Design of Residential Foundations – Version 2

**By the Texas Section of the
American Society of Civil Engineers**

Section 1. INTRODUCTION

1.1 Objective

The function of a residential foundation is to support the structure. The majority of foundations constructed in Texas consist of shallow, stiffened and reinforced slab-on-ground foundations. Many are placed on expansive clays and/or fills. Foundations placed on expansive clays and/or fills have an increased potential for movement and resulting distress.

National building codes have general guidelines which may not be sufficient for the soil conditions and construction methods in the State of Texas. The purpose of this document is to present recommended practice for the design of residential foundations to augment current building codes to help reduce foundation related problems. Where the recommendations in this document vary from published methods or codes, the differences represent the experience and judgment of the majority of the committee members.

On sites having expansive clay, fill, and/or other adverse conditions, residential foundations shall be designed by licensed engineers utilizing the provisions of this document. Expansive clay is defined as soil having a weighted plasticity index greater than 15 as defined by Building Research Advisory Board (BRAB) or a maximum potential volume change greater than 1 percent. This provision should also apply where local geology or experience indicates that active clay soils may be present. We propose that local and state governing bodies adopt this recommended practice.

1.2 Limitation

This recommended practice has been developed by experienced professional engineers and presents practices they commonly employ to help deal effectively with soil conditions that historically have created problems for residential foundations in Texas. This recommended practice presumes the existence of certain standard conditions when, in fact, the combination of variables associated with any given project always is unique. Experienced engineering judgment is required to develop and implement a scope of service best suited to the variables involved. For that reason, the developers of this document have made an effort to make the document flexible. Thus, successful application of this document requires experienced engineering judgment; merely following the guidelines may not achieve a satisfactory result. Unless adherence to this document is made mandatory through force of law or by contractual

reference, adherence to it shall be deemed voluntary. This document does not, of itself, comprise the standard of care which engineers are required to uphold.

1.3 Adopted Changes

The Texas Section of the American Society of Civil Engineers (ASCE) has adopted procedures for changing the guidelines. In general, those interested in submitting changes for consideration by the Section should access the website at www.texasce.org, and follow the instructions for submitting changes. Changes may also be submitted in writing to the Texas Section-ASCE, 1524 S. IH-35, Suite 180, Austin, 78704, phone 512.472.8905. fax 512.472.5641. Anonymous changes will not be considered. Those submitting changes should include contact information, state why a change is proposed, include applicable calculations if appropriate, and provide alternative language to incorporate the change. The appropriate committee will consider the changes, and from time to time the Texas Section may adopt the changes and issue revised Guidelines.

Section 2. DEFINITION OF “ENGINEERED FOUNDATION”

An engineered foundation is defined as one for which design is based on three phases:

- a. geotechnical information supplied by a licensed engineer
- b. the design of the foundation is performed by a licensed engineer
- c. construction is observed with written documentation

These phases are described herein.

Section 3. DESIGN PROFESSIONALS' ROLES AND RESPONSIBILITIES

3.1 Geotechnical Services

Prior to foundation design, a geotechnical investigation and report shall be completed by a geotechnical engineer.

3.2 Design Services

The foundation design engineer shall prepare the plans and specifications for the foundation, and shall be the engineer of record. The foundation shall be built in accordance with the design. The engineer of record shall approve any design modifications. The geotechnical and foundation design engineering may be performed by the same individual.

3.3 Construction Phase Services

The engineer of record shall specify on the plans that construction phase observations shall be incorporated into the foundation construction. These activities shall be performed by: the engineer of record or a qualified delegate. The qualified delegate may be a staff member under his/her direct supervision, or outside agent approved by the engineer of record. The observation reports shall be provided to the engineer of record. The engineer of record shall issue a compliance letter as described in Section 6.3.

Section 4. GEOTECHNICAL INVESTIGATION

4.1 Minimum Field Investigation Program

The geotechnical engineer, in consultation with the engineer of record, if available, shall lay out the proposed exploration program. A minimum exploration program for subdivisions shall cover the geographic and topographic limits of the subdivision, and shall examine believed differences in geology in sufficient detail to provide information and guidance for secondary investigations, if any. The geotechnical exploration program should take into account site conditions, such as vegetation, depth of fill, drainage, seepage areas, slopes, fence lines, old roads or trails, man-made constructions, the time of year regarding seasonal weather cycles and other conditions that may affect foundation performance.

As a minimum for unknown but believed to be uniform subsurface conditions, borings shall be placed at maximum 300 foot centers across a subdivision. Non-uniform subsurface conditions may require additional borings. One soil boring may be sufficient for a single lot investigated in isolation for a simple residence under 2500 square feet. However, more borings may be required on sites having fill, having large footprints, or noticeably varying geological conditions such as steep slopes or locations near known fault zones or geological transitions.

Borings shall be a minimum of 20 feet in depth unless confirmed rock strata is encountered at a lesser depth. However, if the upper 10 ft of soils are found to be predominately cohesionless, then the boring depth may be reduced to 15 ft. Borings shall extend through any known fill or potentially compressible materials even if greater depths are required.

All borings shall be sampled at a minimum interval of one per two feet of boring in the upper 10 feet and at 5-foot intervals below that. In clayey soil conditions, relatively undisturbed tube samples should be obtained. In granular soils, samples using Standard Penetration Tests should be obtained. Borings shall be sampled and logged in the field by a geotechnically trained individual and all borings shall be sampled such that a geotechnical engineer may examine and confirm the driller's logs in the laboratory.

Exploration may either be by drill rig or by test pit provided the depth requirements are satisfied. Sites, which are obviously rock with outcrops showing or easily discoverable by shallow test pits, may be investigated and reported without resorting to drilled borings.

Field logs shall note inclusions, such as roots, organics, fill, calcareous nodules, gravel and man-made materials. The presence or absence of free water in the borehole shall be noted. If encountered, the depth to water shall be logged. Additional water level measurements shall be taken at the discretion of the geotechnical engineer.

4.2 Minimum Laboratory Testing Program

The geotechnical engineer, in consultation with the engineer of record, if available, shall develop the laboratory testing program. Sufficient laboratory testing shall be performed to identify significant strata and soil properties found in the borings across the site. Such tests may include:

- a. Dry Density
- b. Moisture Content
- c. Atterberg Limits
- d. Pocket Penetrometer Estimates of Cohesive Strength
- e. Torvane
- f. Strength Tests
- g. Swell and/or Shrinkage Tests
- h. Hydrometer Testing
- i. Sieve Size Percentage
- j. Soil Suction
- k. Consolidation

All laboratory testing shall be performed in general accordance with the American Society for Testing and Materials (ASTM) or other recognized standards.

4.3 Geotechnical Report

4.3.1 Report Contents

Geotechnical reports shall contain, as a minimum:

- a. purpose and scope, authorization and limitations of services
- b. project description, including design assumptions
- c. investigative procedures
- d. laboratory testing procedures
- e. laboratory testing results
- f. logs of borings and plan(s) showing boring locations
- g. site characterization
- h. foundation design information and recommendations
- i. Professional Engineer's seal

4.3.2 Site Characterization

The geotechnical engineer shall characterize the site for design purposes. The report shall comment on site conditions which may affect the foundation design, such as:

- a. topography including drainage features and slopes
- b. trees and other vegetation
- c. seeps
- d. stock tanks

- e. fence lines or other linear features
- f. geologic conditions
- g. surface faults, if applicable
- h. subsurface water conditions
- i. areas of fill detected at the time of the investigation
- j. other man made features

4.3.3 Foundation Design Information and Recommendations

Reports shall contain the applicable design information and recommendations requested by the engineer of record for each lot in the project. If the engineer of record is not known at the time of the geotechnical report, the following design information should be presented, if applicable.

4.3.3.1 Soil movement potential as determined by the estimated depth of the active zone in combination with at least two of the following methods (identify each method used):

- a. Potential Vertical Rise (PVR) as determined by the Texas Department of Transportation Method 124-E, using soil moisture conditions from dry to wet. The average vertical stress in the soil layers should be used in the calculations to derive the PVR.
- b. Swell tests
- c. Suction and hydrometer tests
- d. Linear Shrinkage tests
- e. Any other method which can be documented and defended as good engineering practice in accordance with the principles of unsaturated soil mechanics

4.3.3.2 BRAB design information including:

- a. Climatic Rating (C_w) of the site
- b. Weighted Plasticity Index
- c. Bearing capacity of the soil

4.3.3.3 Post-Tensioning Institute (PTI) parameters (using their most current design manual and technical notes) including:

- a. e_m and y_m for edge lift and center lift modes (The e_m and y_m in the PTI design manual are based on average climate controlled soil movements and the design recommendations should take into account the added effect of trees and other environmental effects, as noted in the PTI design manual).
- b. Bearing capacity of the soil.
- c. If suction values are used to determine the depth and value of suction equilibrium or evaluate special conditions such as trees, the values

shall be determined using laboratory suction tests. y_m determination shall be based on suction profile change and laboratory determined values of suction-compression index.

d. e_m and y_m shall be reported for design conditions for suction profile varying from equilibrium, and for probable extreme suction conditions.

4.3.3.4 Wire Reinforcing Institute (WRI) parameters including:

- a. Climatic Rating (C_w) of the site
- b. Weighted Plasticity Index
- c. Slope Correction Coefficient (C_s)
- d. Consolidation Correction Coefficient (C_o)

4.3.3.5 Deep Foundation (pier/pile) design information including:

- a. Bearing capacity and skin friction along the pier length
- b. Pier types and depths, and bearing strata
- c. Uplift pressures on the pier and estimated depth of active zone (pier depth must be below the active zone and provide proper anchorage to resist the uplift pressures)
- d. Down drag effects on the piers

4.3.3.6 Shallow foundations (including post and beam footings) design parameters.

- a. Bearing capacity and footing depth
- b. Minimum bearing dimension

4.3.3.7 Soil treatment method(s) to reduce the soil movement potential and the corresponding reduction in predicted movement.

4.3.3.8 Lateral pressures on any retaining structures or on piers undergoing lateral forces.

4.3.3.9 Trees and other site environment concerns that may affect the foundation design. Information useful for design and construction of residential foundations is presented in Appendix A.

4.3.3.10 Moisture control procedures to help reduce soil movement.

4.3.3.11 Surface drainage recommendations to help reduce soil movement.

4.3.3.12 Potential for load induced settlement.

4.3.3.13 On sloping sites, recommend whether a slope stability analysis is required due to possible downhill creep or other instability that may be present.

4.3.3.14 The presence and methods of dealing with existing and proposed fill. Fill criteria useful for design and construction of residential foundations is presented in Appendix B.

4.3.3.15 Geotechnical considerations related to construction.

Section 5. DESIGN OF FOUNDATIONS

5.1 Design Information

The foundation design engineer shall obtain sufficient information for the design of the foundation. This may include:

- a. information gathered by a site visit
- b. the subdivision plan, site plan or plat
- c. the topography of the area including original and proposed final grades
- d. the geotechnical report
- e. special project requirements
- f. the project budget
- g. the architectural elevations and floor plans and sufficient additional architectural information to determine the magnitude, construction materials and location of structural loads on the foundation
- h. exposed or architectural concrete schedule, if applicable

5.2 Design Procedures for Slab on Ground

5.2.1 The foundation engineer shall utilize one of the following methods, with the modifications presented in this section, as a minimum:

- a. BRAB
- b. Finite Element
- c. PTI
- d. WRI
- e. other methods which can be documented and defended as good engineering practice

5.2.2 Input variables for residential slab-on-ground foundations shall be as follows:

5.2.2.1 BRAB:

- a. Use the current design manual and technical notes, and the following design provisions:
 - a.1 Regardless of the actual beam length, the analysis length should be limited to a maximum of 50 ft; and
 - a.2 Use a maximum long term creep factor as provided in ACI 318, Section 9.5.2.5.

5.2.2.2 Finite Element:

- a. Use soil support parameters that can be documented and defended as good engineering practice in accordance with the principles of unsaturated soil mechanics;

- b. Use a cracked moment of inertia for beams that exceed the cracking moment; and
- c. Use a maximum design deflection ratio of $1 / 360$ (deflection ratio is defined as the maximum deviation from a straight line between any two points divided by the distance between the two points).

5.2.2.3 PTI:

- a. Use the current design manual and technical notes, and the following design provisions.
- b. Provide minimum residual average prestress of 100 psi.
- c. Maintain the calculated prestress eccentricity within 5.0 inches. Bottom beam tendons or rebar reinforcing should always be used.
- d. If the computed concrete tensile stress at service loads, after accounting for prestress losses, exceeds $4\sqrt{f'_c}$, provide bonded additional reinforcement at the top or bottom of the beam as required by tensile forces equal to 0.0033 times the gross beam section. The transformed area of steel may be used to determine a new stiffness value for the beam.
- e. The e_m and y_m in the PTI design manual are based on average climate controlled soil movements and the design analysis should take into account the added effect of trees and other environmental effects, as noted in the PTI design manual.

5.2.2.4 WRI:

- a. Use the current design manual and technical notes, and the following design provisions.
- b. Regardless of the actual beam length, the analysis length should be limited to a maximum of 50 ft; and
- c. The minimum design length (L_c) shall be 6 ft.

5.2.3 Design Considerations

The foundation design engineer should consider the following (deviation shall be based on generally accepted engineering practice):

5.2.3.1 The latest ACI publications.

5.2.3.2 Exterior corners may require special stiffening. This can be accomplished with diagonal beams or parallel interior beams near the perimeter beams.

5.2.3.3 Provide continuous beams at reentrant corners. For post tensioned foundations, all exterior and interior beams should be continuous. For conventionally reinforced beams, interior beams may be discontinuous as long as the beam is continued a distance equal to at least twice the L_c distance.

- 5.2.3.4 Provide stiffening beams perpendicular to offsets (such as fireplaces or bay windows) in perimeter beams when the offset exceeds 18-inches.
- 5.2.3.5 Provide interior beams at concentrated loads such as fireplaces, columns and heavy interior line loads.
- 5.2.3.6 Sites with soil movement potential (see Section 4.3.3.1) exceeding 1.0 inch should have special design considerations such as strengthened sections, revised footprint, site soil treatment, or structurally suspended foundation if any of the following conditions is present:
 - a. a shape factor (SF) exceeding 20, (SF = perimeter squared divided by area)
 - b. extensions over 12 ft.
- 5.2.3.7 Slab-on-ground foundations with piers shall be designed as stiffened soil supported slabs for heave conditions and as structurally suspended foundations with the beams and slabs spanning between piers for shrinkage and settlement conditions. Piers shall not be attached to the slabs or grade beams unless the connections and foundation systems are designed to account for the uplift forces.

5.3 Design Procedures for Structurally Suspended Foundations

- 5.3.1 Structurally suspended floors supported by deep foundations shall be designed in accordance with applicable building codes.

5.4 Design Procedures for Footing Supported Foundations

- 5.4.1 Design in accordance with applicable building codes.
- 5.4.2 Shallow individual or continuous footing foundations should not be used on expansive soils, unless the superstructure is designed to account for the potential foundation movement.

5.5 Minimum Foundation Plan and Specification Information

- 5.5.1 Plans shall be signed and sealed by the engineer of record, and be specific for each site or lot location. Plans shall identify the client's name, the engineer's name, address and telephone number; and the source of the geotechnical data.
- 5.5.2 The engineer's drawings shall contain as a minimum:
 - a. a plan view of the foundation locating all major structural components and reinforcement
 - b. sufficient information to show details of beams, piers, retaining walls, drainage details, etc., if such features are integral to the foundation

- c. sufficient information for the proper construction and observation by field personnel
- d. information or notes addressing minimum perimeter and lot drainage requirements

5.5.3 The engineer's specifications shall include as a minimum:

- a. descriptions of the reinforcing or pre-stressing cables and hardware;
- b. concrete specifications including compressive strengths;
- c. site preparation requirements;
- d. notes concerning nearby existing or future vegetation and the required design features to accommodate these conditions; and
- e. a listing of the required construction observations and testing.

5.5.4 The engineer's plan shall address site fill:

- a. The plans shall address fill existing at the time of the design or to be placed during construction of the foundation and shall require any fills which are to support the bearing elements of the foundation to be tested and approved by a geotechnical engineer assisted by a qualified laboratory (Bearing elements of a suitably designed slab-on-ground foundation are defined as the bottoms of exterior or interior stiffener beams.)
- b. The plan shall require that a geotechnical engineer issue a summary report describing the methods, and results of investigation and testing that were used, and a statement that the existing or placed fills are suitable for support of a shallow soil-supported slab-on-ground, or that the foundation elements should penetrate the fill to undisturbed material. See Appendix B for more detailed information on fills.

Section 6. CONSTRUCTION PHASE OBSERVATIONS

6.1 Responsibility for Observations

Construction phase observations and testing shall be performed in accordance with this document.

6.2 Minimum Program of Observation and Testing

At a minimum, foundations should be observed and tested as applicable to determine whether:

- a. exposed subgrade soils are prepared in accordance with the plans and specifications;
- b. fill material and placement are in accordance with the plans and specifications;
- c. pier placement, size and depth meet plans and specifications;
- d. foundation elements, including reinforcement, meet plans and specifications immediately before concrete placement;
- e. concrete properties and placement meet plans and specifications;
- f. for post tension slabs, stressing meets the specified elongation and stressing load of each tendon; and.
- g. specified site grading and drainage has been constructed.

6.3 Compliance Letter

6.3.1 At the satisfactory accomplishment of the requirements of the plans and specifications, the engineer of record shall provide a letter to the client indicating, to the best of his knowledge (which may be based on observation reports by a qualified delegate as defined in Section 3.3), the construction of the foundation was in substantial conformance with:

- a. the minimum standards of practice presented in this document; and
- b. the engineer's plans and specifications including any modifications or alterations authorized.

6.3.2 A non-compliance letter shall be issued if the construction of the foundation did not meet the requirements of Section 6.3.1.

APPENDIX A

IMPACT OF MOISTURE CHANGES ON EXPANSIVE SOILS

Most problems resulting from expansive soils involve swelling or shrinking as evidenced by upward or downward movement of the foundation producing distress to the structure. The difference between the water content at the time of construction and the equilibrium water content is an important consideration. Potential swell increases with lower initial moisture content, while potential shrinkage increases with higher initial moisture content. Moisture contents and shrink/swell movements may vary seasonally even after equilibrium is reached.

Precipitation and evapotranspiration control soil moisture and groundwater levels. A slab will greatly reduce the evapotranspiration rate beneath the slab and partially reduces the inflow due to precipitation or irrigation because of groundwater's ability to migrate laterally. Therefore, soils beneath a slab are frequently wetter than soils at the same depth away from the slab. However, a wet season may result in wetter conditions away from the slab than under the slab. With time and normal precipitation patterns, the soil moisture profile will return to its normal condition. Seasonal variations in soil moisture away from the slab will generally occur fairly quickly. Seasonal variations in soil moisture beneath the slab will be slower. In addition roots from trees and large vegetation will seasonally remove moisture from nearby soils.

Wetting of expansive soils beneath slabs can occur as a result of lateral migration or seepage of water from the outside. It can be aggravated by ponded water resulting from poor drainage around the slab or landscape watering. Leaking utility lines and excessive watering of soil adjacent to the structure can also result in foundation heave.

Foundations can experience downward movement as the result of the drying influence of nearby trees. As trees and large bushes grow, they withdraw greater amounts of water from the soil causing downward foundation movement. The area near trees removed shortly before construction may be drier and subject to localized heave.

Some construction and maintenance issues include the following:

- a. In general, set top of concrete at least eight inches above final adjacent soil grade for damp proofing.
- b. For adjacent ground exposed or vegetative areas, provide adequate drainage away from the foundation (minimum five percent slope in the first ten feet and minimum two percent slope elsewhere). The bottom of any drainage swale should not be located within four feet of the foundation. Pervious planting beds should slope away from the foundation at least two inches per foot. Planting bed edging shall allow water to drain out of the beds.

- c. Gutters or extended roof eaves are recommended, especially under all roof valleys. For adjacent ground exposed or vegetative areas, all extended eaves or gutter down spouts should extend at least two feet away from the foundation and past any adjacent planting beds.
- d. Avoid placement of trees and large vegetation near foundations (taking into account the water demands of specific trees and vegetation).

APPENDIX B

IMPACT OF FILL ON FOUNDATIONS

B.1 FILL

Fill is frequently a factor in residential foundation construction. Fill may be placed on a site at various times. If the fill has been placed prior to the geotechnical investigation, the geotechnical engineer should note fill in the report. Fill may exist between borings or be undetected during the geotechnical investigation for a variety of reasons. The investigation becomes more accurate if the borings are more closely spaced. Occasionally, fill is placed after the geotechnical investigation is completed, and it may not be detected until foundation excavation is started.

If uncontrolled fill (see discussion below) is discovered later in the construction process, for instance, by the Inspector after the slab is completely set up and awaiting concrete, great expense may be incurred by having to remove reinforcing and forms to provide penetration through the fill. Therefore, it is important to identify such materials and develop a strategy for dealing with them early on in the construction process. Fill can generally be divided into three types: engineered fill, forming fill, and uncontrolled fill. These three types of fill are discussed below.

B.1.1 Engineered Fill

Engineered fill is that which has been designed by an engineer to act as a structural element of a constructed work and has been placed under engineering inspection, usually with density testing. Engineered fill may be of at least two types. One type is “embankment fill,” which is composed of the material randomly found on the site, or imported to no particular specification, other than that it be free of debris and trash. Embankment fill can be used for a number of situations if properly placed and compacted. “Select fill” is the second type of engineered fill. The term “select” simply means that the material meets some specification as to gradation and P.I., and possibly some other material specifications. Normally, it is placed under controlled compaction with engineer inspection. Examples of select fill could be crushed limestone, specified sand, or crusher fines which meet the gradation requirements. Select underslab fill is frequently used under shallow foundations for purposes of providing additional support and stiffness to the foundation, and replacing a thickness of expansive soil. Engineered fill should meet specifications prepared by a qualified engineer for a specific project, and includes requirements for placement, geometry, material, compaction and quality control.

B.1.2 Forming Fill

Forming fill is that which is typically used under residential foundation slabs and is variously known as sandy loam, river loam or fill dirt. Forming fill is normally not expected to be heavily compacted, and a designer should not rely on this material for support. The only requirements are that this material be non-expansive, clean, and that it works easily and stands when cut. If forming fill happened to be properly compacted and inspected in accordance with an engineering specification it could be engineered fill.

B.1.3 Uncontrolled Fill

Uncontrolled fill is fill that has been determined to be unsuitable (or has not been proven suitable) to support a slab-on-ground foundation. Any fill that has not been approved by a qualified geotechnical engineer in writing shall be considered uncontrolled fill. Uncontrolled fill may contain undesirable materials and/or has not been placed under compaction control. Some problems resulting from uncontrolled fill include gradual settlement, sudden collapse, attraction of wood ants and termites, corrosion of metallic plumbing pipes, and in some rare cases, site contamination with toxic or hazardous wastes.

B.2 Building on Non-Engineered (Forming Or Uncontrolled) Fill

Foundations shall not be supported by non-engineered fill. To establish soil supported foundations on non-engineered fill, the typical grid beam stiffened slab foundation is required to penetrate the non-engineered fill with the perimeter and interior beam bottoms forming footings. Penetration will take the load supporting elements of the foundation below the unreliable fill. Penetration could be accomplished by deepened beams, spread footings or piers depending on the depth and the economics of the situation. Generally, piers are most cost effective once the fill to be penetrated exceeds about three feet, but this depends on the foundation engineer's judgment and local practice. Floor systems shall be designed to span between structurally supported foundation elements.

Pre-existing fill may be classified as engineered fill after investigation by the geotechnical engineer. The approval may depend on the fill thickness, existence of trash and debris, the age of the fill, and the results of testing and proof rolling. The geotechnical engineer must be able to expressly state after investigation that the fill is capable of supporting a residential slab-on-ground foundation.

Reinforcing Steel Conversion Table

U.S. Customary to Metric

Steel Reinforcement Conversion Table		
Sizes and Dimensions		
U.S. Customary Designation	Nominal Diameter in Inches (not including the deformations)	Metric Bar Designation
#3	0.375	10
#4	0.500	13
#5	0.625	16
#6	0.750	19
#7	0.875	22
#8	1.000	25
#9	1.128	29

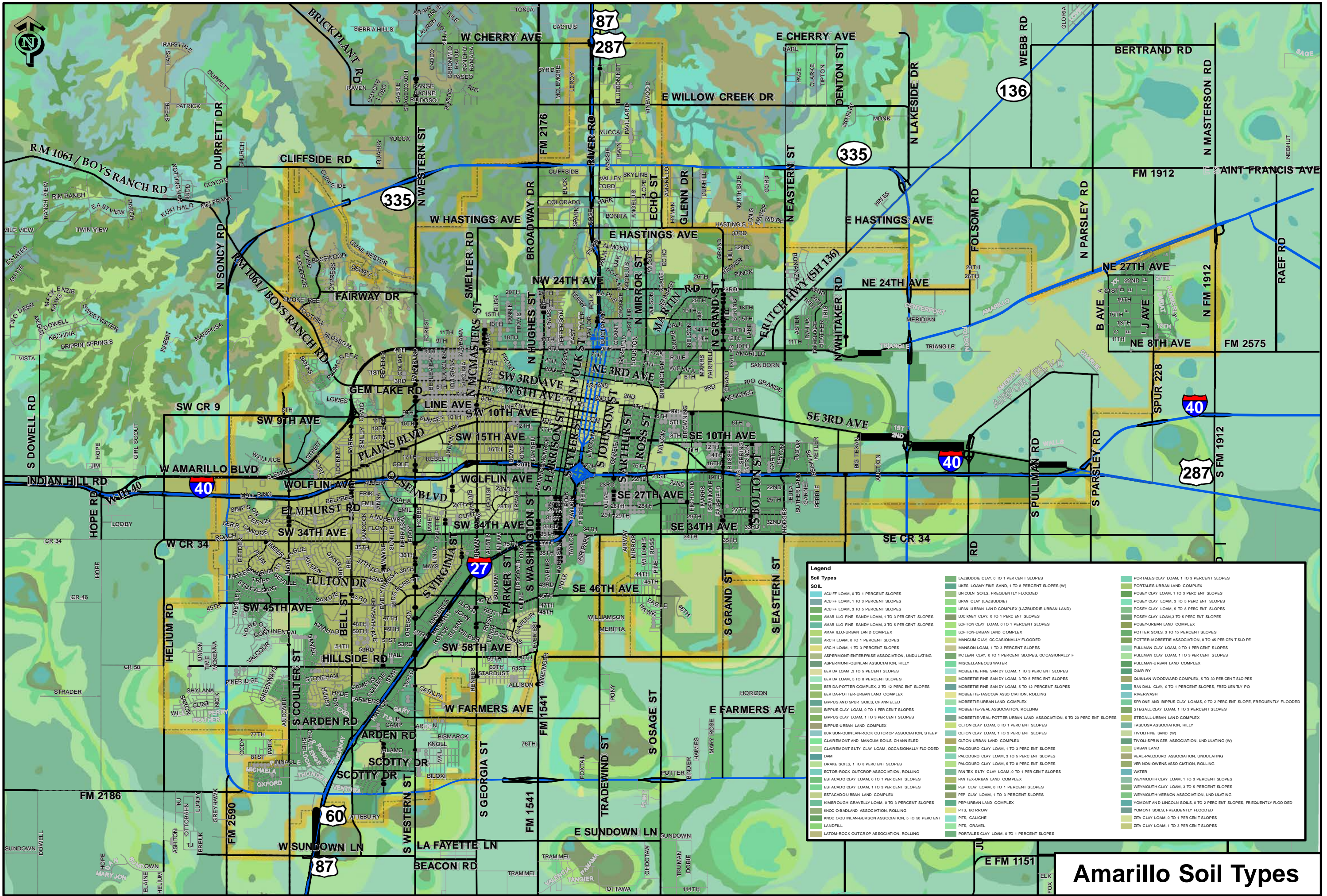

Legend

Soil Types	Soil	Soil Types	Soil
ACU FF LOAM, 0 TO 1 PERCENT SLOPES	LAZBUDDIE CLAY, 0 TO 1 PERCENT SLOPES	PORTALES CLAY LOAM, 1 TO 3 PERCENT SLOPES	PORTALES CLAY LOAM, 1 TO 3 PERCENT SLOPES
ACU FF LOAM, 1 TO 3 PERCENT SLOPES	LIKES LOAMY FINE SAND, 1 TO 8 PERCENT SLOPES (W)	POSEY CLAY LOAM, 1 TO 3 PERCENT SLOPES	POSEY CLAY LOAM, 1 TO 3 PERCENT SLOPES
ACU FF LOAM, 3 TO 5 PERCENT SLOPES	LIN COLN SOILS, FREQUENTLY FLOODED	POSEY CLAY LOAM, 3 TO 5 PERCENT SLOPES	POSEY CLAY LOAM, 3 TO 5 PERCENT SLOPES
AMARILLO FINE SANDY LOAM, 1 TO 3 PERCENT SLOPES	LIPAN CLAY (LAZBUDDIE)	POSEY CLAY LOAM, 5 TO 8 PERCENT SLOPES	POSEY CLAY LOAM, 5 TO 8 PERCENT SLOPES
AMARILLO FINE SANDY LOAM, 3 TO 5 PERCENT SLOPES	LIPAN URBAN LAND COMPLEX (LAZBUDDIE-URBAN LAND)	POSEY CLAY LOAM, 8 TO 10 PERCENT SLOPES	POSEY CLAY LOAM, 8 TO 10 PERCENT SLOPES
AMARILLO FINE SANDY LOAM, 5 TO 8 PERCENT SLOPES	LOC MEY CLAY, 0 TO 1 PERCENT SLOPES	POTTER SOILS, 3 TO 15 PERCENT SLOPES	POTTER SOILS, 3 TO 15 PERCENT SLOPES
AMARILLO FINE SANDY LOAM, 8 TO 10 PERCENT SLOPES	LOFTON CLAY LOAM, 0 TO 1 PERCENT SLOPES	POTTER-MOBEETIE ASSOCIATION, 8 TO 45 PERCENT SLOPE	POTTER-MOBEETIE ASSOCIATION, 8 TO 45 PERCENT SLOPE
AMARILLO FINE SANDY LOAM, 10 TO 15 PERCENT SLOPES	LOFTON-URBAN LAND COMPLEX	PULLMAN CLAY LOAM, 0 TO 1 PERCENT SLOPES	PULLMAN CLAY LOAM, 0 TO 1 PERCENT SLOPES
ARC H LOAM, 0 TO 1 PERCENT SLOPES	MANGUM CLAY, OCCASIONALLY FLOODED	PULLMAN CLAY LOAM, 1 TO 3 PERCENT SLOPES	PULLMAN CLAY LOAM, 1 TO 3 PERCENT SLOPES
ARC H LOAM, 1 TO 3 PERCENT SLOPES	MANSON LOAM, 1 TO 3 PERCENT SLOPES	PULLMAN-URBAN LAND COMPLEX	PULLMAN-URBAN LAND COMPLEX
ASPERMONT-ENTERPRISE ASSOCIATION, UNULATING	MCCLEAN CLAY, 0 TO 1 PERCENT SLOPES, OCCASIONALLY F	QUARRY	QUARRY
ASPERMONT-QUINLAN ASSOCIATION, HILLY	MISCELLANEOUS WATER	QUINLAN-WOODWARD COMPLEX, 5 TO 30 PERCENT SLOPES	QUINLAN-WOODWARD COMPLEX, 5 TO 30 PERCENT SLOPES
BERDA LOAM, 3 TO 5 PERCENT SLOPES	MOBEETIE FINE SANDY LOAM, 1 TO 3 PERCENT SLOPES	RAN DALL CLAY, 0 TO 1 PERCENT SLOPES, FREQUENTLY FLOODED	RAN DALL CLAY, 0 TO 1 PERCENT SLOPES, FREQUENTLY FLOODED
BERDA LOAM, 5 TO 8 PERCENT SLOPES	MOBEETIE FINE SANDY LOAM, 3 TO 5 PERCENT SLOPES	RIVERWASH	RIVERWASH
BERDA-POTTER COMPLEX, 2 TO 12 PERCENT SLOPES	MOBEETIE FINE SANDY LOAM, 5 TO 8 PERCENT SLOPES	SPR ONE AND BIPPUS CLAY LOAMS, 0 TO 2 PERCENT SLOPE, FREQUENTLY FLOODED	SPR ONE AND BIPPUS CLAY LOAMS, 0 TO 2 PERCENT SLOPE, FREQUENTLY FLOODED
BERDA-POTTER-URBAN LAND COMPLEX	MOBEETIE-TASCOSA ASSOCIATION, ROLLING	STEGALL CLAY LOAM, 1 TO 3 PERCENT SLOPES	STEGALL CLAY LOAM, 1 TO 3 PERCENT SLOPES
BIPPUS AND SPUR SOILS, CHANN ELED	MOBEETIE-URBAN LAND COMPLEX	STEGALL-URBAN LAND COMPLEX	STEGALL-URBAN LAND COMPLEX
BIPPUS CLAY LOAM, 0 TO 1 PERCENT SLOPES	MOBEETIE-VEAL ASSOCIATION, ROLLING	TASCOSA ASSOCIATION, HILLY	TASCOSA ASSOCIATION, HILLY
BIPPUS CLAY LOAM, 1 TO 3 PERCENT SLOPES	MOBEETIE-VEAL-POTTER URBAN LAND ASSOCIATION, 5 TO 20 PERCENT SLOPES	TIVOLI FINE SAND (W)	TIVOLI FINE SAND (W)
BIPPUS-URBAN LAND COMPLEX	OLTON CLAY LOAM, 0 TO 1 PERCENT SLOPES	TIVOLI-SPRING GER ASSOCIATION, UNULATING (W)	TIVOLI-SPRING GER ASSOCIATION, UNULATING (W)
BURSON-QUINLAN-ROCK OUTCROP ASSOCIATION, STEEP	OLTON CLAY LOAM, 1 TO 3 PERCENT SLOPES	URBAN LAND	URBAN LAND
CLAIREMONT AND MANGUM SOILS, CHANN ELED	OLTON-URBAN LAND COMPLEX	VEAL-PALODURO ASSOCIATION, UNULATING	VEAL-PALODURO ASSOCIATION, UNULATING
CLAIREMONT SLTLY CLAY LOAM, OCCASIONALLY FLOODED	PALODURO CLAY LOAM, 1 TO 3 PERCENT SLOPES	VERNON-OWENS ASSOCIATION, ROLLING	VERNON-OWENS ASSOCIATION, ROLLING
DAM	PALODURO CLAY LOAM, 3 TO 5 PERCENT SLOPES	WATER	WATER
DRAKE SOILS, 1 TO 8 PERCENT SLOPES	PALODURO CLAY LOAM, 5 TO 8 PERCENT SLOPES	WEYMOUTH CLAY LOAM, 1 TO 3 PERCENT SLOPES	WEYMOUTH CLAY LOAM, 1 TO 3 PERCENT SLOPES
ECTOR-ROCK OUTCROP ASSOCIATION, ROLLING	PAN TEX SLTLY CLAY LOAM, 0 TO 1 PERCENT SLOPES	WEYMOUTH CLAY LOAM, 3 TO 5 PERCENT SLOPES	WEYMOUTH CLAY LOAM, 3 TO 5 PERCENT SLOPES
ESTACADO CLAY LOAM, 0 TO 1 PERCENT SLOPES	PAN TEX-URBAN LAND COMPLEX	WEYMOUTH-VERNON ASSOCIATION, UNULATING	WEYMOUTH-VERNON ASSOCIATION, UNULATING
ESTACADO CLAY LOAM, 1 TO 3 PERCENT SLOPES	PEP CLAY LOAM, 0 TO 1 PERCENT SLOPES	YOMONT AND LINCOLN SOILS, 0 TO 2 PERCENT SLOPES, FREQUENTLY FLOODED	YOMONT AND LINCOLN SOILS, 0 TO 2 PERCENT SLOPES, FREQUENTLY FLOODED
ESTACADO-URBAN LAND COMPLEX	PEP CLAY LOAM, 1 TO 3 PERCENT SLOPES	YOMONT SOILS, FREQUENTLY FLOODED	YOMONT SOILS, FREQUENTLY FLOODED
KIMBROUGH GRAVELLY LOAM, 0 TO 3 PERCENT SLOPES	PITS, BO RROW	ZITA CLAY LOAM, 0 TO 1 PERCENT SLOPES	ZITA CLAY LOAM, 0 TO 1 PERCENT SLOPES
KNOX OBADLAND ASSOCIATION, ROLLING	PITS, CALICHE	ZITA CLAY LOAM, 1 TO 3 PERCENT SLOPES	ZITA CLAY LOAM, 1 TO 3 PERCENT SLOPES
KNOX OGU INLAN-BURSON ASSOCIATION, 5 TO 50 PERCENT	PITS, GRAVEL		
LANDFILL			
LATOM-ROCK OUTCROP ASSOCIATION, ROLLING			

Amarillo Soil Types

This publication provides interpretive drawings considered to comply or exceed the requirements of chapter 4 of International Residential Code and are approved for use in One & Two Family Dwellings in the following municipalities:

- City of Amarillo
- City of Canyon
- City of Dimmitt
- City of Friona
- City of Herford
- City of Tulia

This material published April 2017 for use with the International Residential Code.

It is not intended to replace the basic need for good engineering judgment based on appropriate education, experience, wisdom and ethics in any particular engineering application.